







Attuale

 Selezione o tópicos:

	CORES.....	03
	PLATAFORMAS.....	04
	MESAS.....	11
	BALCÕES.....	24
	COMPLEMENTOS.....	29

Cores disponíveis

Madeiras - Light



01-COBALTO



02-CRISTAL



03-OVO



06-ARGILA

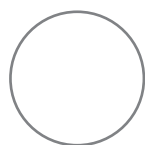

07-BRANCO

Madeiras - Color



05-PRETO



15-CARVALHO PRATA



16-GRAFITE



17 - CARVALHO AVELÃ



20 - MAPLE BILBAO

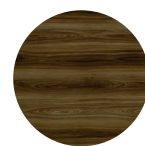

22-ÁLAMO



25-LANARCA



30-CARVALHO HANOVER



59-ITAPUÃ



66-TRANCOSO

Metálicos



02-CRISTAL



03-OVO

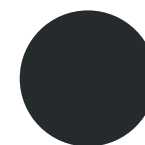

05-PRETO



06-ARGILA

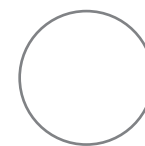

07-BRANCO

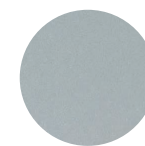

12-ALUMÍNIO



16-GRAFITE



Instrução de Cores

Mesas:

- COR 1 - Tampos
- COR 2 - Pés e Painéis Frontais em BP
- COR 3 - Calha de fiação do pé e painéis frontais em aço

Balcões:

- COR 1 - Tampos superior e inferior
- COR 2 - Pés e Painéis Frontais em BP
- COR 3 - Calha de fiação do pé e painéis frontais em aço

Plataformas:

- COR 1 - Tampos principais
- COR 2 - Pés e Paineis Frontais
- COR 3 - Calha de fiação do pé





PLATAFORMAS

Sumário

Novidades.....	05
Plataformas - Visão geral	07
Plataforma Simples Módulo Central / Módulo Supervisor	07
Plataforma Simples Módulo Auxiliar.....	07
Plataforma Dupla Módulo Central.....	07
Plataforma Dupla Módulo Auxiliar	07
Exemplos de Montagens.....	08
Componentes Metálicos	10

Novidades - Plataformas

✓ **Novo sistema de eletrificação**



Moldura Basic tamanho médio "M"

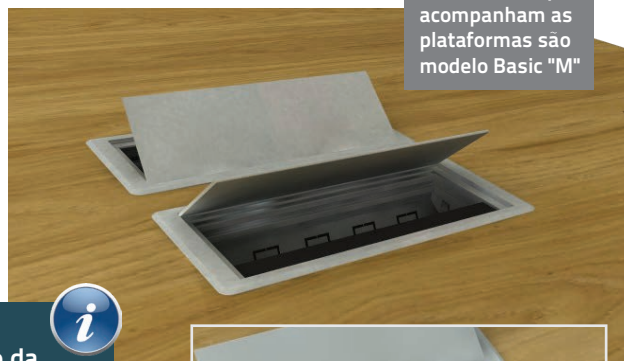

As molduras que acompanham as plataformas são modelo Basic "M"



O sistema de eletrificação da linha Attuale foi atualizado. Agora as plataformas contam com calha elétrica, suporte para tomadas, e moldura de acabamento para acesso de elétrica, dados e voz.

- As calhas elétricas, suportes para tomadas e molduras de acabamento estão inclusos em todas as plataformas.



Configuração dos suportes: 4 pontos para elétrica
2 pontos para dados e voz

Obs: Plugs não inclusos



Calha elétrica para acomodar e organizar a fiação.

Novidades - Plataformas

Instalações elétricas

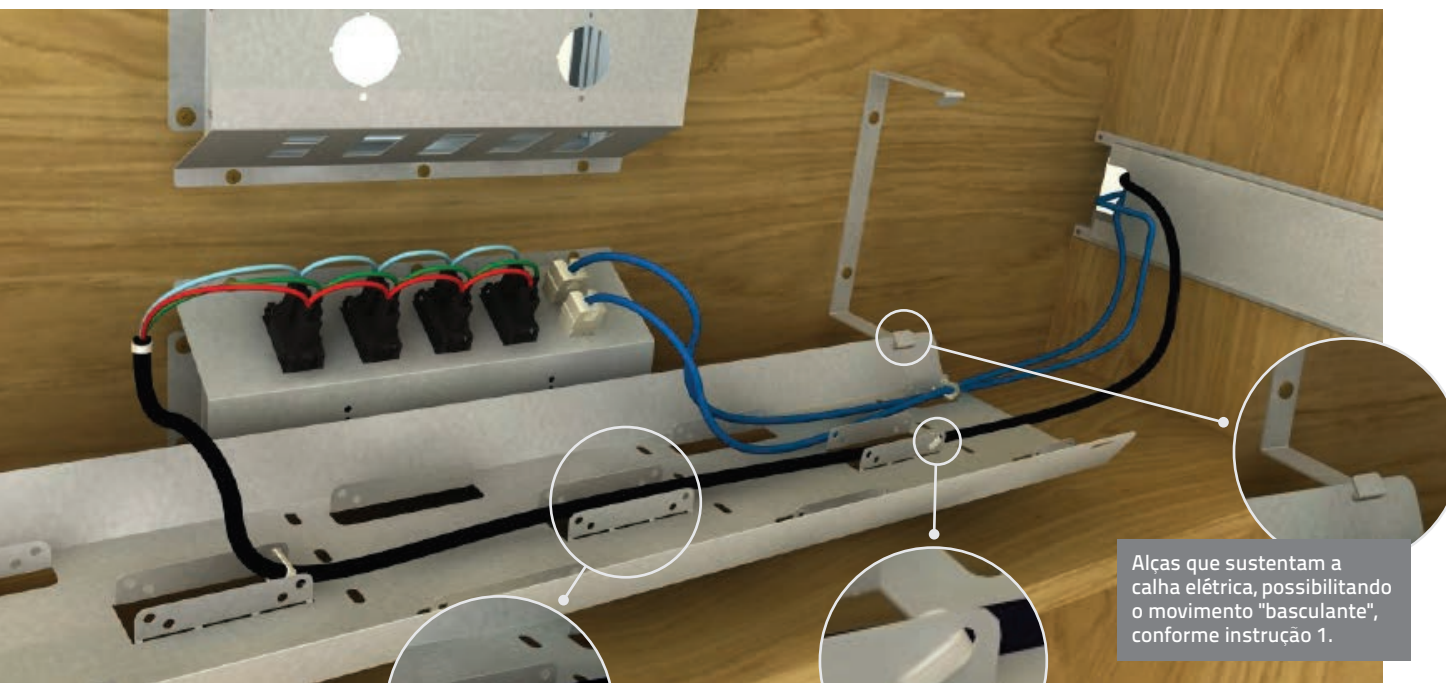

i Levantando as abas auxiliares, formam-se 3 canais para passagem da fiação (elétrica, dados e voz), facilitando a separação dos fios.

Abas dobradas manualmente conforme instrução 2.

Alças que sustentam a calha elétrica, possibilitando o movimento "basculante", conforme instrução 1.

Furos para fixação de abraçadeiras para organização dos fios.

Instruções de utilização da calha

1 - Basculamento da calha

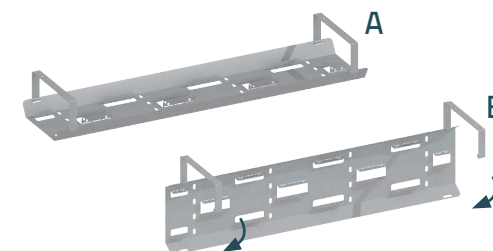

Soltando um dos lados da alça, é possível deixar a calha na posição vertical para manutenção do sistema elétrico.

2 - Abas organizadoras da calha

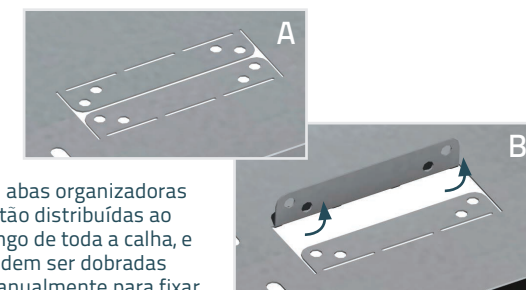

As abas organizadoras estão distribuídas ao longo de toda a calha, e podem ser dobradas manualmente para fixar e organizar a fiação.

Plataformas - Visão geral

Plataforma Simples Módulo Central / Módulo Supervisor

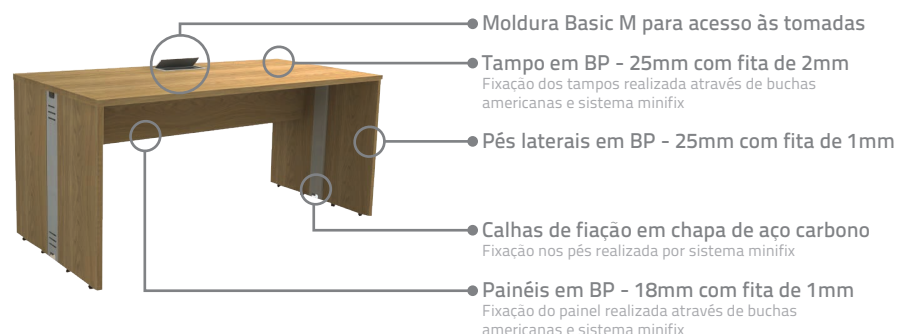

Plataforma Simples Módulo Auxiliar

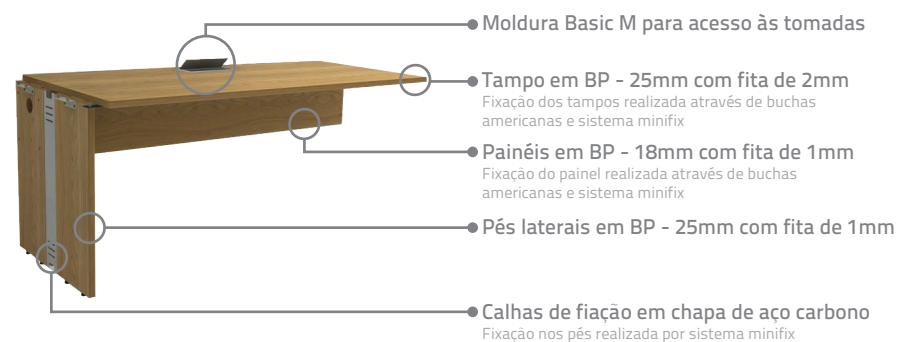

Plataforma Dupla Módulo Central

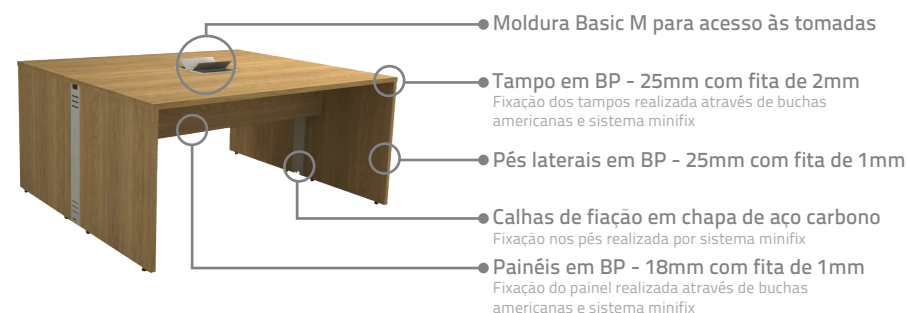

Plataforma Dupla Módulo Auxiliar

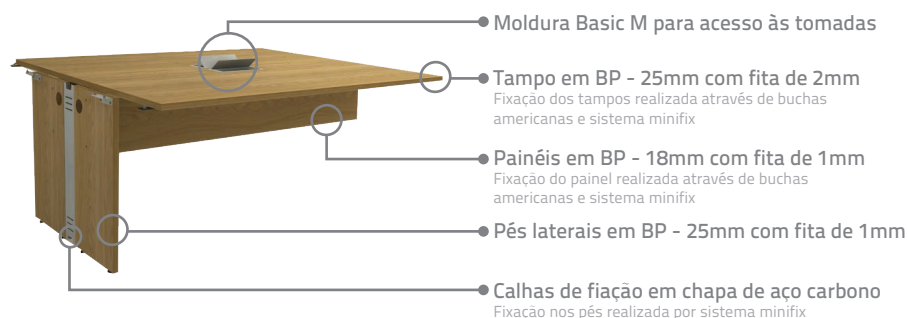

Exemplos de montagens

Plataforma Dupla 4 lugares

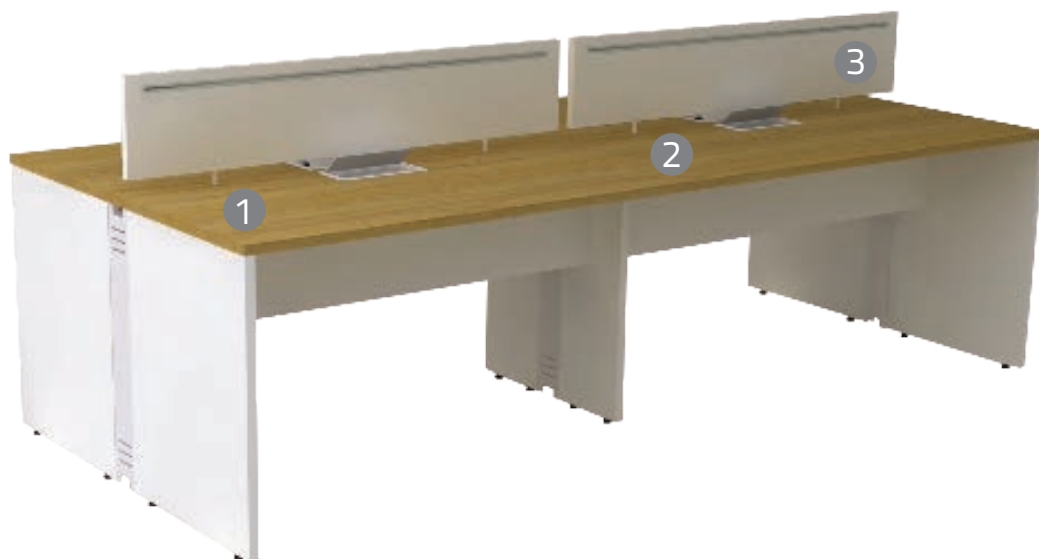

- 1 Módulo Central Plataforma Dupla Attuale 1350x1200mm
- 2 Módulo Auxiliar Plataforma Dupla Attuale 1350x1200mm
- 3 Biombo com friso Work Pro 1300mm

i O procedimento para montagem de módulos é igual para Plataformas Simples e Plataformas Duplas.

Sistema de montagem

1. Solte um dos pés do Módulo Central (pode ser qualquer um dos lados).

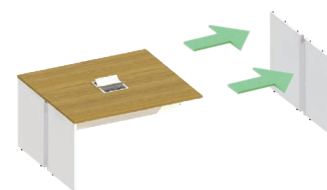

2. Acrescente o Módulo Auxiliar e fixe-o no lugar onde estava o pé lateral retirado no passo anterior.



3. Com o Módulo Auxiliar devidamente fixado, faça o fechamento da plataforma com o pé lateral que foi solto no 1º passo.



4. Fixe os parafusos dos pés para finalizar a montagem.



Obs: Se for necessário inserir mais módulos, antes de fazer o fechamento deve-se repetir o 2º passo até atingir a quantidade de lugares desejada.

Exemplos de montagens



- ① Módulo Central Plataforma Dupla Attuale 1350x1400mm
- ② Módulo Auxiliar Plataforma Dupla Attuale 1350x1400mm
- ③ Biombo com friso Work Pro 1300mm
- ④ Biombo Lateral J Plataforma Work Pro
- ⑤ Gaveteiro Volante 1 Gaveta + Pasta IP

Calha dos Pés Laterais

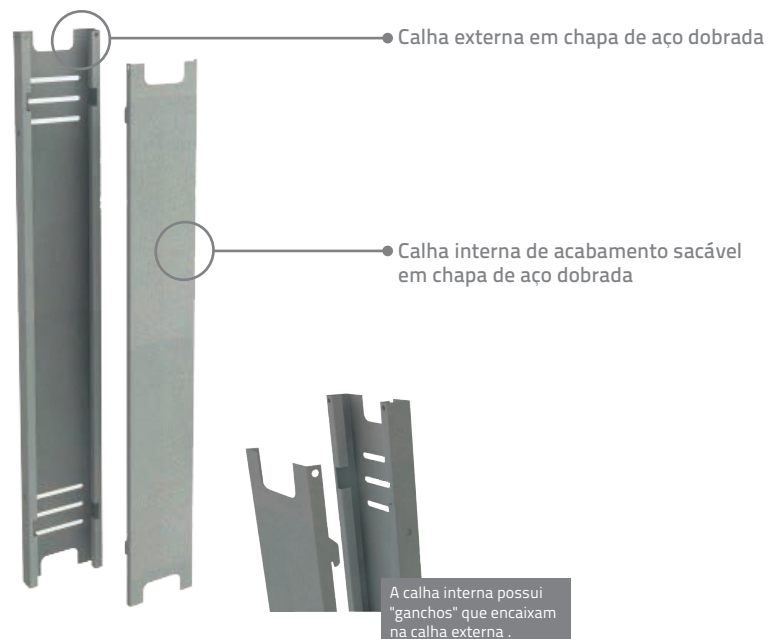

Calhas Elétricas e Suportes de Tomadas

Para plataformas Simples e Dupla

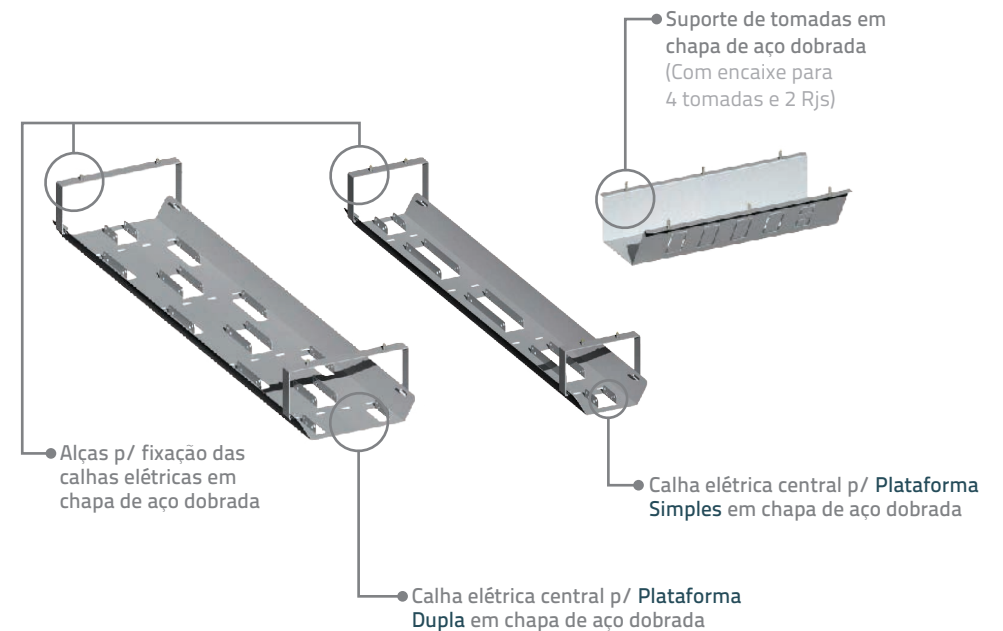



MESAS

Sumário

Novidades.....	12
Mesas - Visão geral.....	14
Mesa Retã	14
Delta Angular.....	14
Delta Atendimento.....	14
Delta Peninsular.....	14
Reunião Retangular.....	15
Reunião Retangular bipartida	15
Reunião Oval.....	15
Reunião Oval bipartida	15
Reunião Semi-oval	16
Reunião Semi-oval bipartida	16
Reunião Redonda.....	16
Módulo Diretor.....	18
Mesa Auxiliar.....	18
Mesa Auxiliar Canto.....	18
Mesa Auxiliar Volante	18
Mesa Diretiva.....	20
Mesa Gota	22
Componentes Metálicos.....	22

Attuale

www.marzovitorino.com.br

Novidades - Mesas

✓ Mesas Reunião com rasgo para caixa de tomadas

As mesas com rasgo p/ caixa de tomada da linha Attuale recebem as caixas de tomada Basic tamanho Médio (M).

- As caixas de tomada são vendidas separadamente.

→ Todas as mesas terão seus códigos sem as caixas de tomadas. As caixas, por sua vez, devem ser escolhidas separadamente nas opções de cores: Preto, Branco ou Alumínio

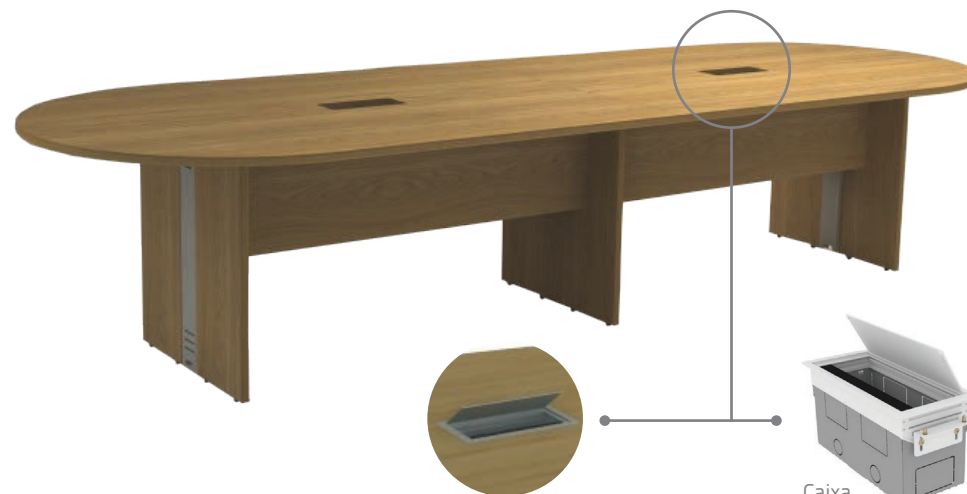

Caixa Basic "M" disponível nas cores:



● 05-PRETO ○ 07-BRANCO ● 12-ALUMÍNIO

Conectividade:

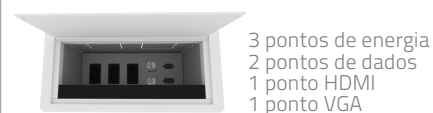

3 pontos de energia
2 pontos de dados
1 ponto HDMI
1 ponto VGA

✓ Mesa Auxiliar Volante



Ampliando a categoria de mesas auxiliares da linha Attuale, a Mesa Auxiliar Volante pode ser utilizada em diversas situações ou em conjunto com outros móveis.

Novidades - Mesas

✓ Mesas Diretivas



As mesas diretivas da linha Attuale devem ser combinadas com armários da linha Work Pro

- As caixa de tomada utilizada nas mesas diretivas é a Caixa Basic tamanho médio (M).

- As caixas de tomadas são vendidas separadamente.



Exemplo:



- 1 Mesa Diretiva Attuale 1800x800mm
- 2 Armário Diretiva Work Pro L/D 1600x500mm *
- 3 Gaveteiro 4 gavetas Diretiva Work Pro *
- 4 Caixa de Tomada Basic "M"

*Produtos da linha Work Pro ainda não disponíveis. Lançamento em breve.

Mesas - Visão geral

Mesa Reta

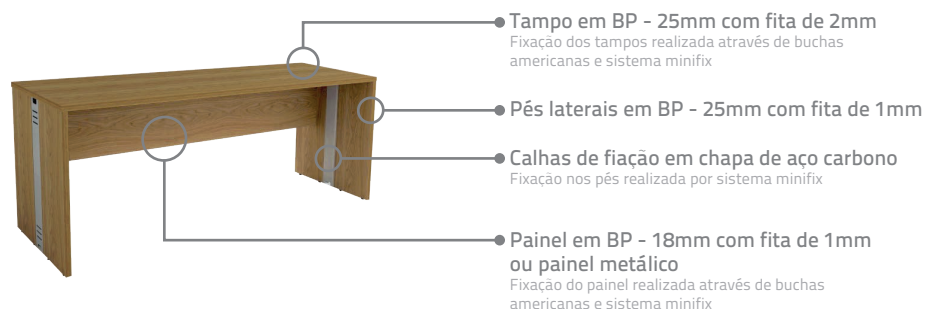

Delta Angular

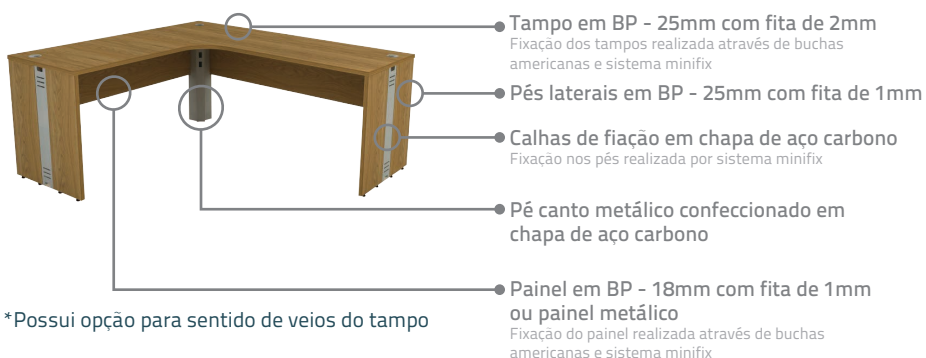

*Possui opção para sentido de veios do tampo

Delta Atendimento

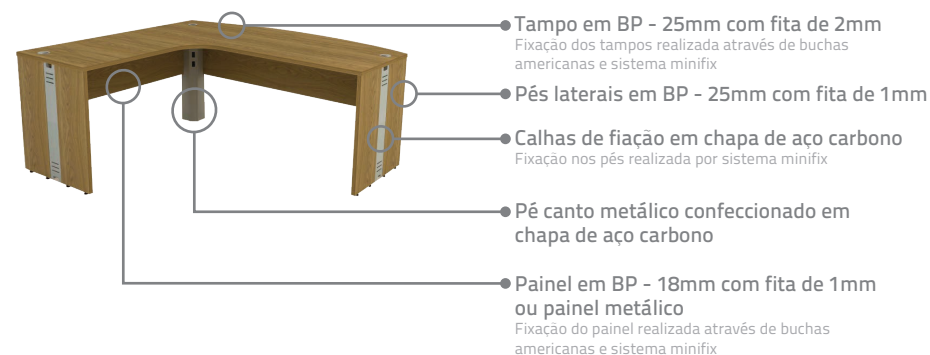

Delta Peninsular

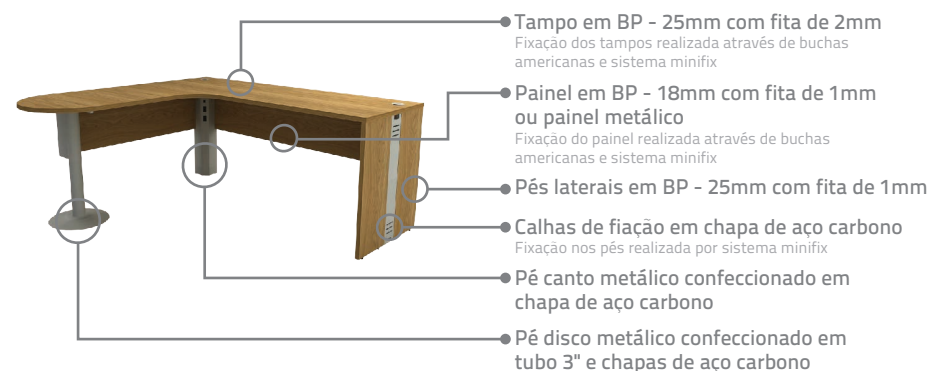

Mesas - Visão geral

Reunião Retangular

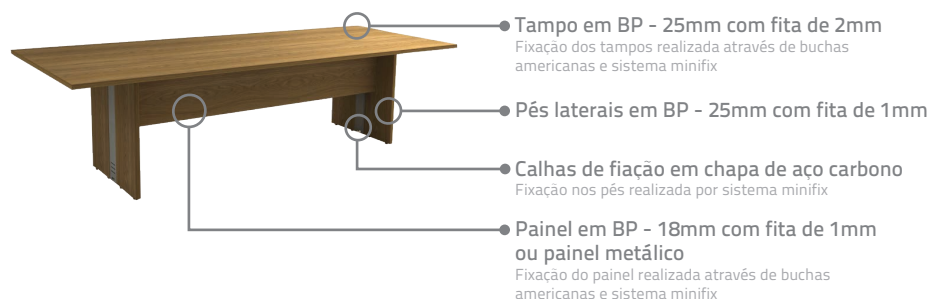

Reunião Retangular bipartida

Mesas com largura de 3000mm e 3500mm possuem tampo bipartido

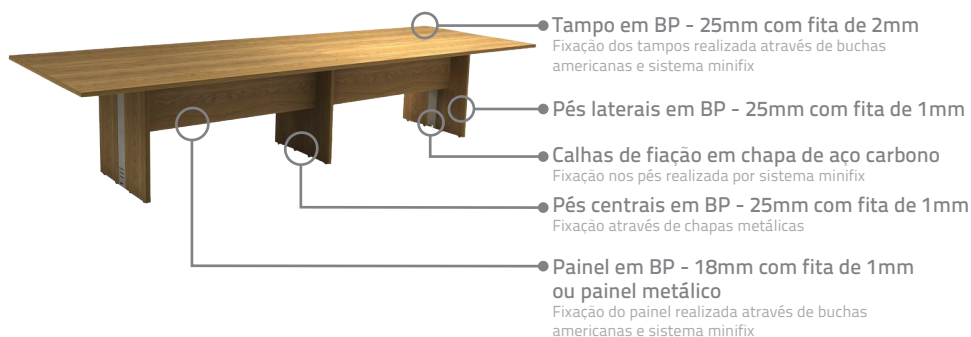

Reunião Oval

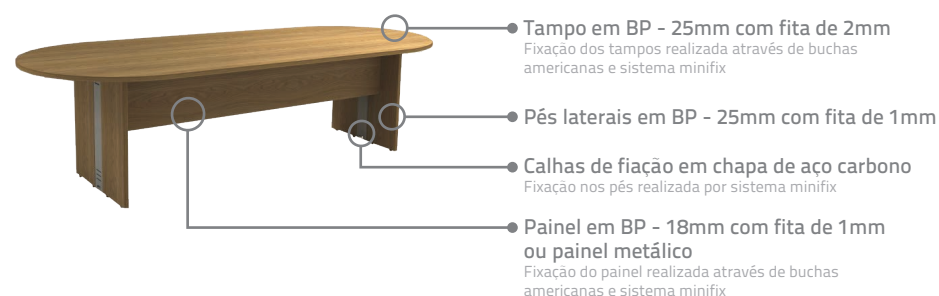

Reunião Oval bipartida

Mesas com largura de 3000mm e 3500mm possuem tampo bipartido

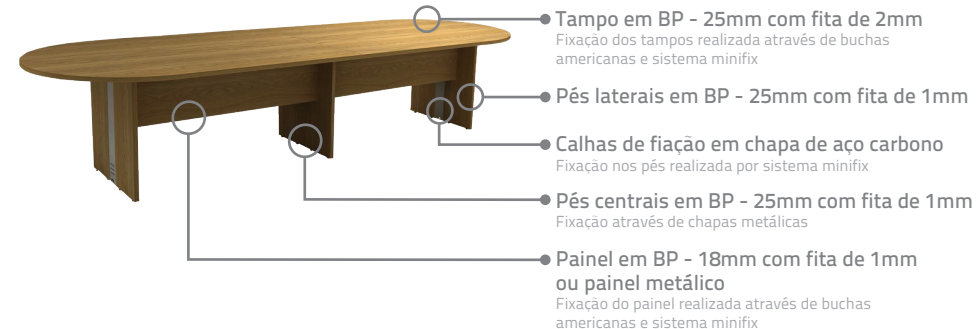

Mesas - Visão geral

Reunião Semi-oval

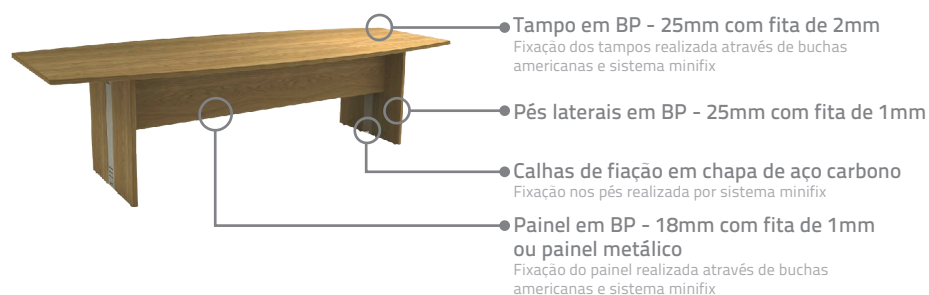

Reunião Semi-oval bipartida

Mesas com largura de 3000mm e 3500mm possuem tampo bipartido

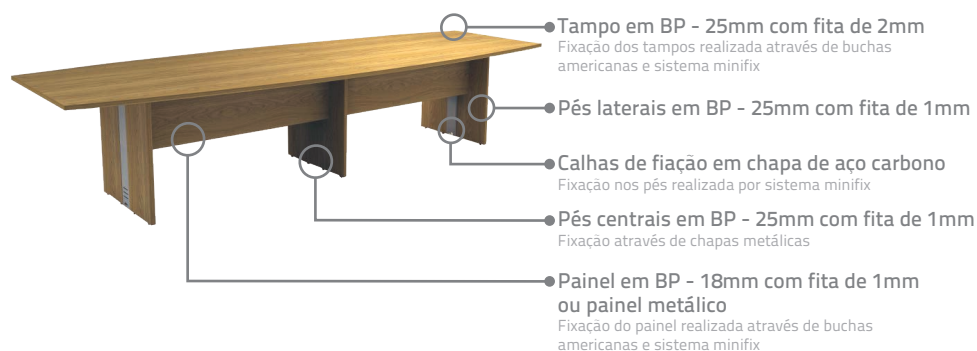

Reunião Redonda

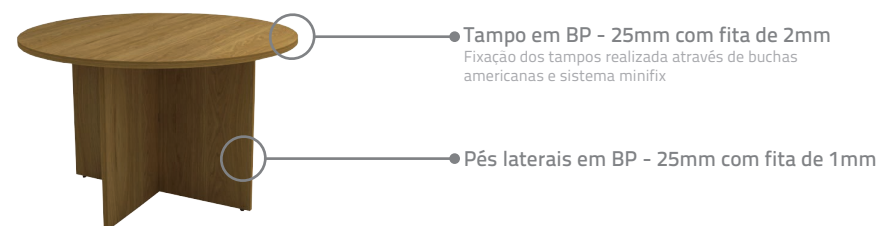

i Todas as mesas reunião dos modelos retangular, semi-oval e oval possuem opção de tampo com rasgo para caixa de tomada "Basic M".

Exemplos:



Obs: Para os demais modelos de caixa de tomada, como Slim e Plus, verificar disponibilidade junto à fábrica.

Exemplos de montagens



- ① Mesa Reunião Semi-Oval Bipartida
2 Cx de Tomadas Attuale 3000x1100mm
- ② Caixa de Tomada Basic "M"

Mesas - Visão geral

Módulo Diretor

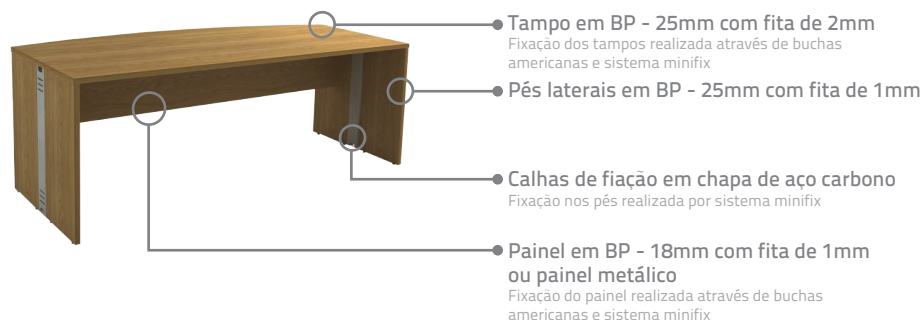

Mesa Auxiliar

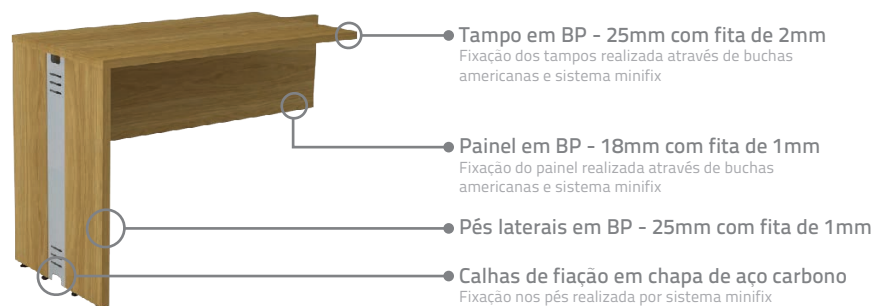

*Possui opção para sentido de veios do tampo

Mesa Auxiliar Canto

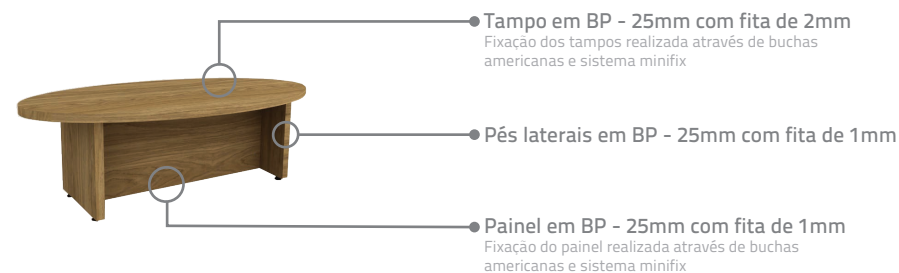

Mesa Auxiliar Volante

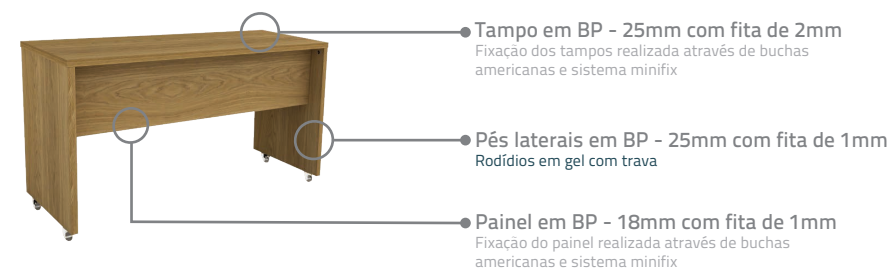

Exemplos de montagens

Combinações

 Os móveis da linha Attuale podem ser combinados com produtos de outras linhas.



- 1 Mesa Reta painel madeira Attuale 1800x600mm
- 2 Mesa Auxiliar com Painel Frontal Attuale 1000x600mm



- 1 Módulo Diretor painel madeira Attuale 2000x950mm
- 2 Armário Nicho porta de correr Impéria Premium



- 1 Mesa Reta painel madeira Attuale 1700x600mm
- 2 Mesa Auxiliar Volante Attuale 1200x500mm

Mesas - Visão geral

Mesa Diretiva

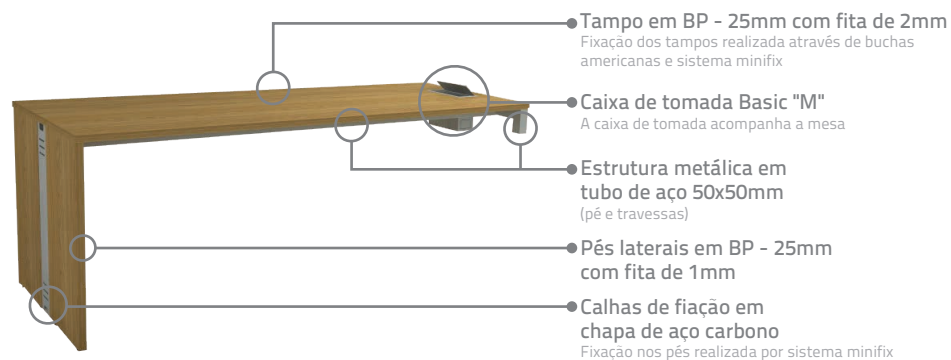

i As Mesas Diretivas devem ser combinadas com armários da linha Work Pro.

Exemplos de montagens



- ① Mesa Diretiva Attuale 1800x800mm
- ② Armário Diretiva Work Pro L/D 1600x500mm *
- ③ Gaveteiro 2 gavetas + pasta Diretiva Work Pro *
- ④ Pannel de fechamento com prateleira Work Pro *
- ⑤ Caixa de Tomada Basic "M"

*Produtos da linha Work Pro ainda não disponíveis. Lançamento em breve.

Exemplos de montagens



- ① Mesa Diretiva Attuale 1600x800mm
- ② Armário Diretiva Work Pro Lado Esq 2000x500mm
- ③ Armário Diretiva Work Pro Lado Dir 2000x500mm
- ④ Gaveteiro Diretiva 4 Gavetas Work Pro
- ⑤ Caixa de Tomada Basic "M"

Mesas - Visão geral

Mesa Gota

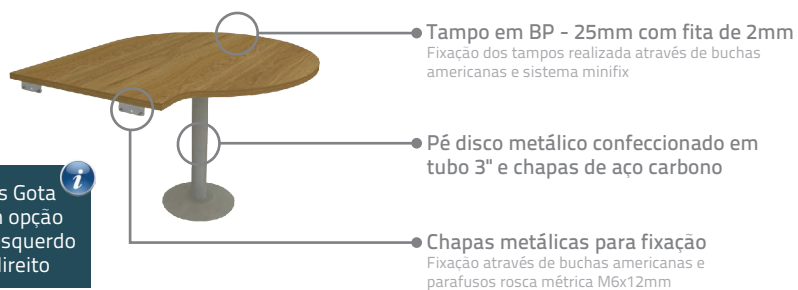

i As mesas Gota possuem opção de lado esquerdo ou aldo direito

Componentes Metálicos - Visão geral

Painel Frontal Aço

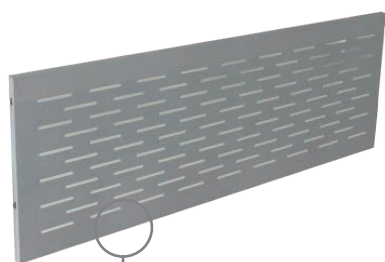

• Painel metálico em chapa de aço dobrada



i Painel metálico utilizado em todos os modelos de mesas que possuem opção de painel frontal em aço.

Calha dos pés laterais

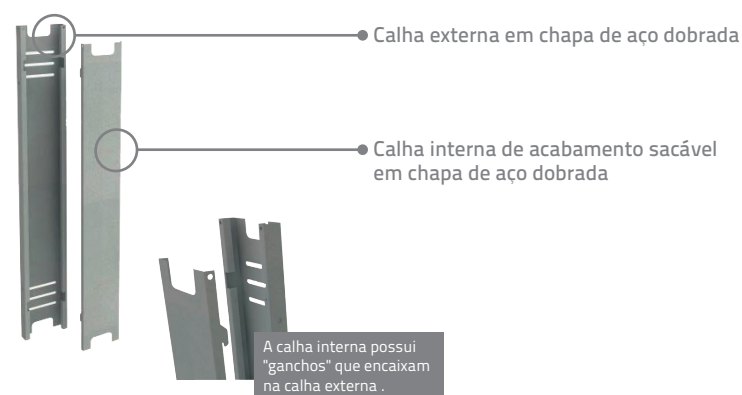

Pé Canto

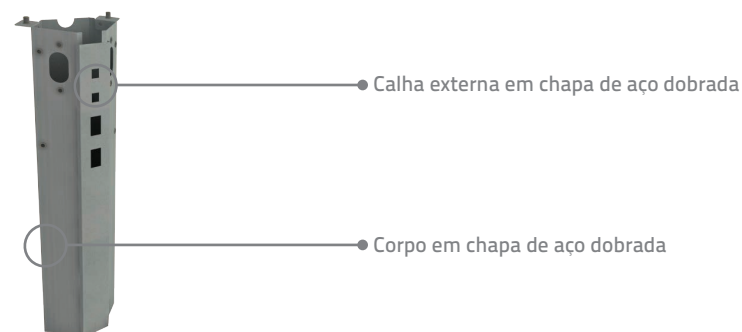

Componentes Metálicos - Visão geral

Estrutura Mesa Diretiva

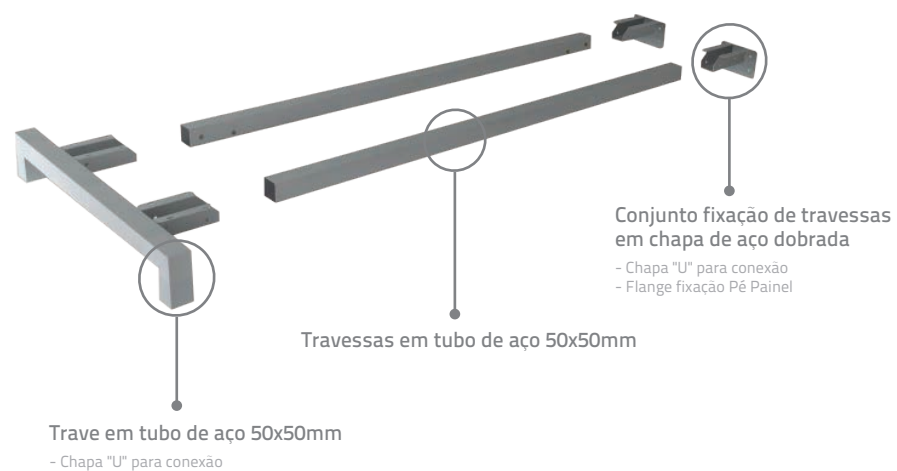

Pé Disco

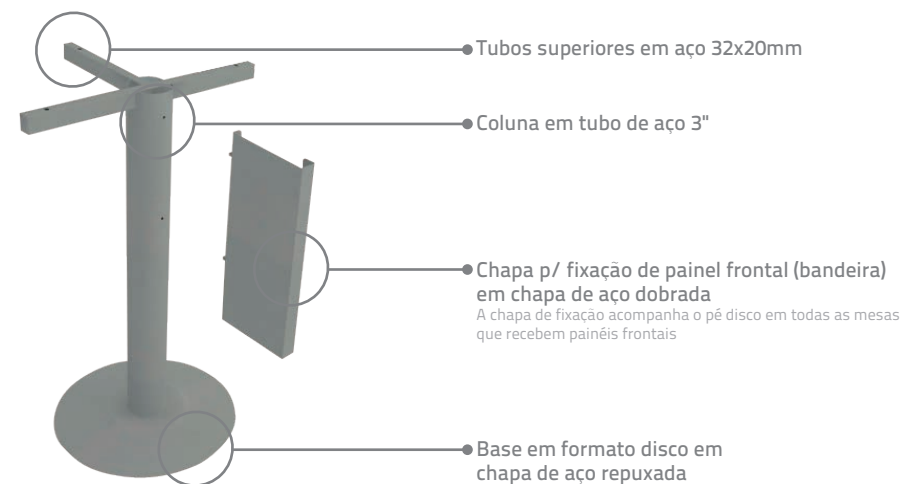



BALCÕES

Sumário

Balcões - Visão geral.....	25
Balcão Reto.....	25
Balcão Reto sem mezanino.....	25
Mezanino Reto para Balcão.....	25
Balcão em L.....	26
Balcão em L sem mezanino.....	26
Exemplos de montagens.....	27
Componentes Metálicos.....	28

Balcões - Visão geral

Balcão Reto

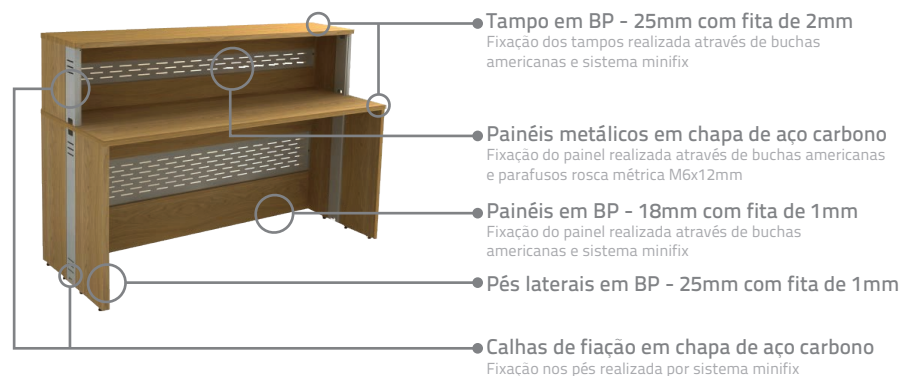

Balcão Reto sem mezanino

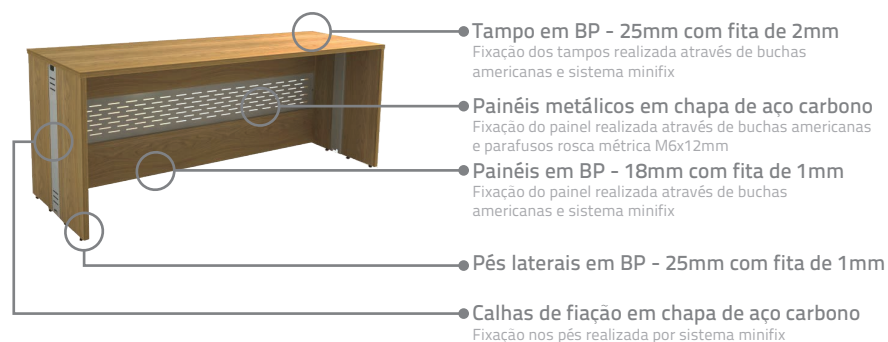

i Os tampos são enviados pré-furados para receber os mezaninos posteriormente, caso seja necessário.

Mezanino Reto para Balcão

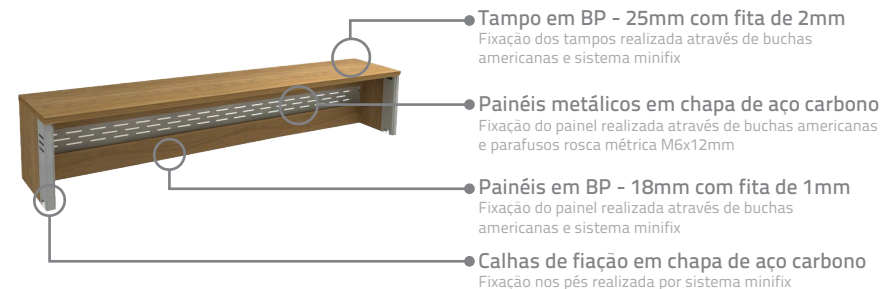

i Todos os balcões dos modelos **Reto**, **Reto sem mezanino** e **Mezanino para Balcão** possuem opções de painéis frontais em madeira ou mesclado (madeira e aço).

Exemplos:



Balcão reto frontal em madeira



Balcão reto frontal mesclado

Balcões - Visão geral

Balcão em L

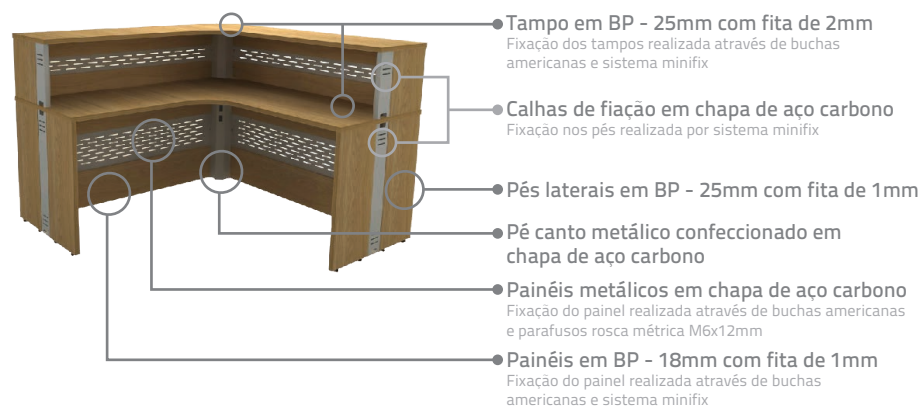

Balcão em L sem mezanino

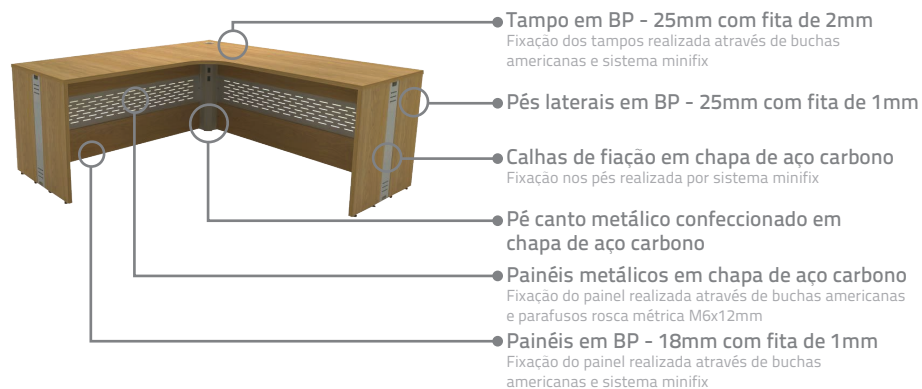

i Os tampo são enviados pré-furados para receber os mezaninos posteriormente, caso seja necessário.

Attuale

i Todos os balcões dos modelos **Reto**, **Reto sem mezanino** e **Mezanino para Balcão** possuem opções de painéis frontais em madeira ou mesclado (madeira e aço).

Exemplos:



Balcão em L frontal em madeira



Balcão em L frontal mesclado

Exemplos de montagens

Aplicação posterior de mezanino:



- 1 Balcão L sem mezanino mesclado Attuale
- 2 Mezanino Reto mesclado Attuale

Exemplos de montagens

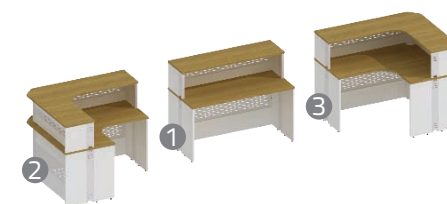

- 1 Balcão Reto mesclado Attuale 1400mm
- 2 Balcão em L mesclado Attuale 1200x1400mm
- 3 Balcão em L mesclado Attuale 1400x1200mm



Os balcões da linha Impéria Premium podem ser combinados de diversas maneiras para compor o ambiente.

Componentes metálicos - Visão geral

Calha dos Pés Laterais e Mesaninos

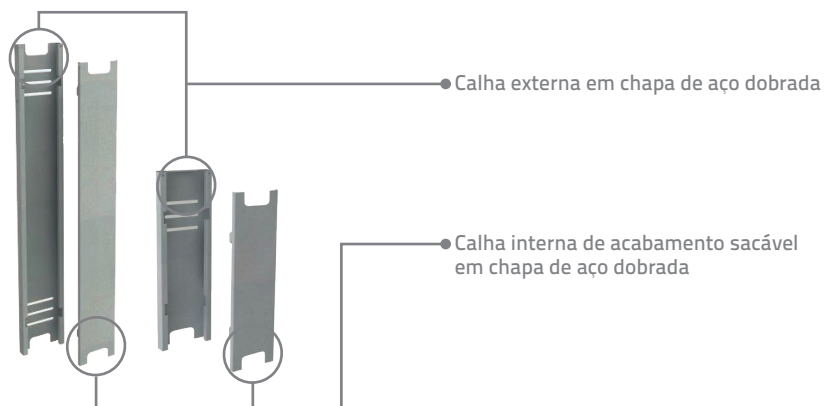

Painel Frontal Aço

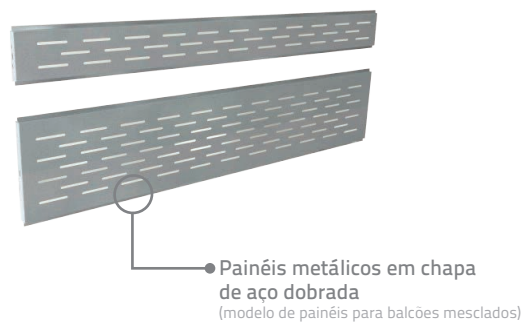

Pé Canto

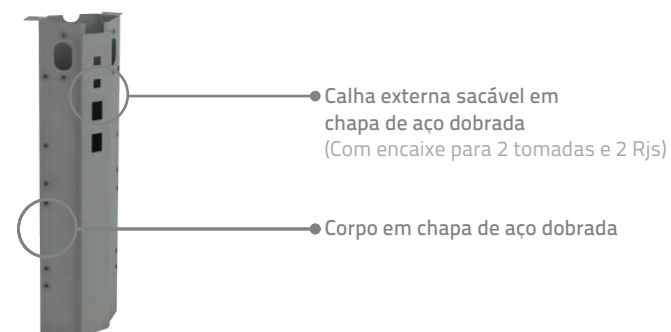

Pé Canto Mesanino

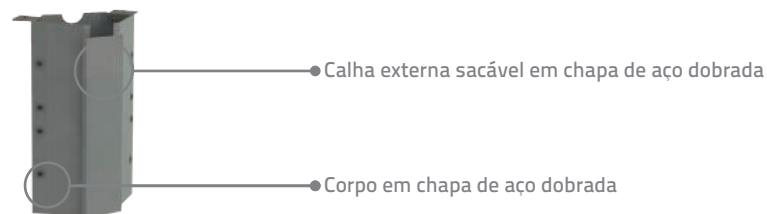



COMPLEMENTOS

Sumário

Complementos - Visão geral	30
Conexões	30
Exemplos de montagens	31

Complementos - Visão geral

Conexões

Conexão Leque

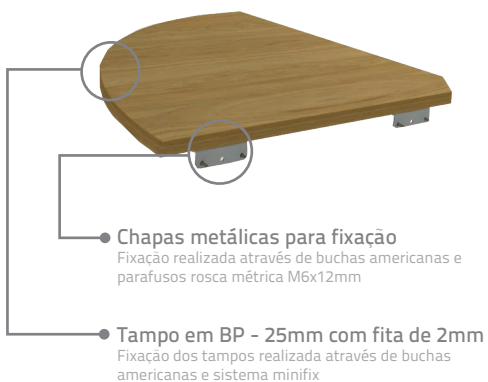

Conexão Quadrada

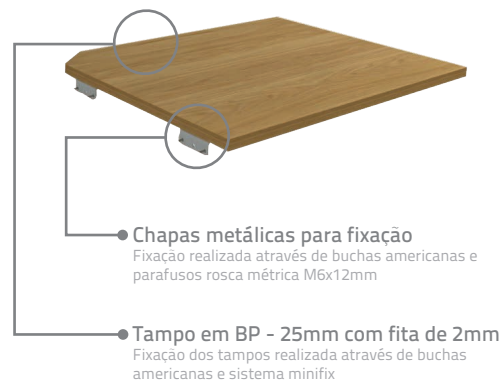

Conexão Meia Lua

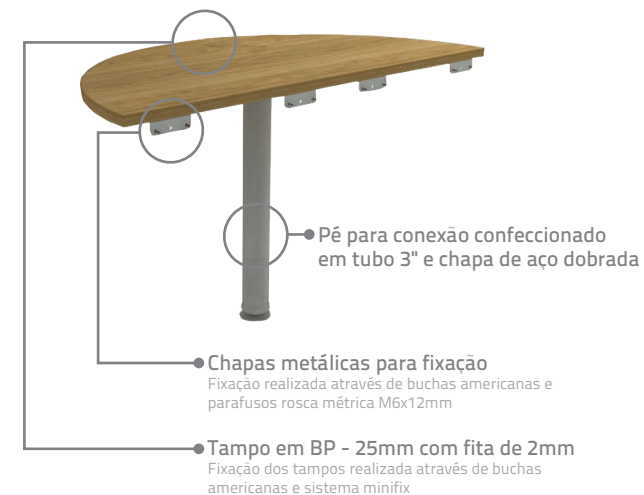

Exemplos de montagens

Montagens com Conexões



- ① Mesa Retá Painel de Aço Attuale 1800x600mm
- ② Conexão Leque Attuale 600x600mm



- ① Mesa Delta Painel de Aço Attuale 1600x1600mm
- ② Conexão Meia Lua Attuale
- ③ Biombo Frontal Chanfrado Impéria Premium 1600x500mm

EasyFIX

Veja também o e-book
de nossa linha de **Acessórios**

marzo vitorino

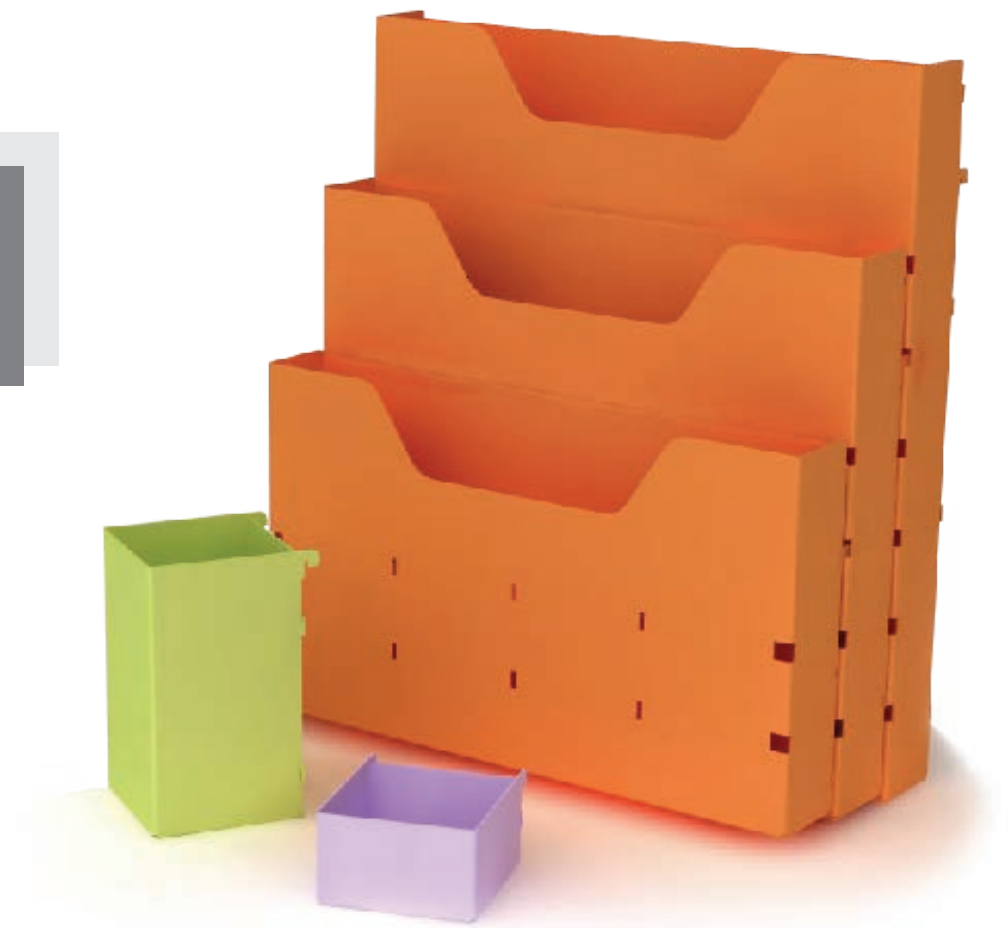

Attuale

marzo vitorino

www.marzovitorino.com.br



A marca do manejo
florestal responsável