

e-Book



marzo vitorino

Work Pro

WorkPro

Selecione o tópico 

■ CORES.....	12
■ PLATAFORMAS.....	13
■ MESAS TUBULARES.....	22
■ DIRETIVAS.....	24
■ MESAS REUNIÃO.....	33
■ ARMÁRIOS.....	45
■ COMPLEMENTOS.....	51
■ BANCADAS.....	62



















WorkPro

Cores disponíveis

Cores Madeiras



Cores Metálicas

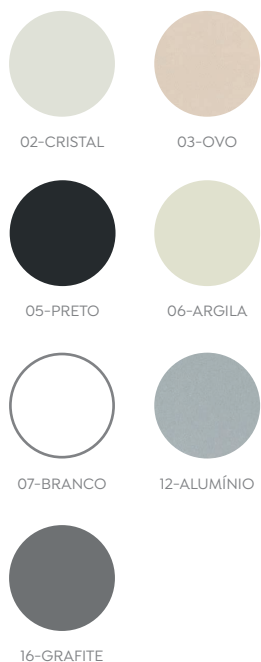

Cores Portas PVC



Cores Molduras Basic



*Molduras Basic vendidas separadamente

Instruções de Cores

Plataformas:

COR 1 - Tampos principais
COR 2 - Tampos Centrais
COR 3 - Estrutura metálica

Mesas:

COR 1 - Tampos
COR 2 - Estrutura metálica

Armários:

COR 1 - Tampos e portas
COR 2 - Caixaaria
COR 3 - Rodapé metálico

Gaveteiros:

COR 1 - Tampos e frentes de gavetas
COR 2 - Caixaaria



Plataformas

Sumário (selecione o item) 

Módulos para Plataforma	14
Módulos para Plataforma / Modelos	14
Pés para Plataformas	15
Pés Trave Elevados	15
Pés Quadro Elevados	15
Pés Cavalete Elevados	16
Pés Cavalete 3D	16
Pés Painel	17
Montagem dos Módulos	18
Eletrificação	19
Exemplos	20

Módulos para Plataforma

Para plataformas Simples e Duplas

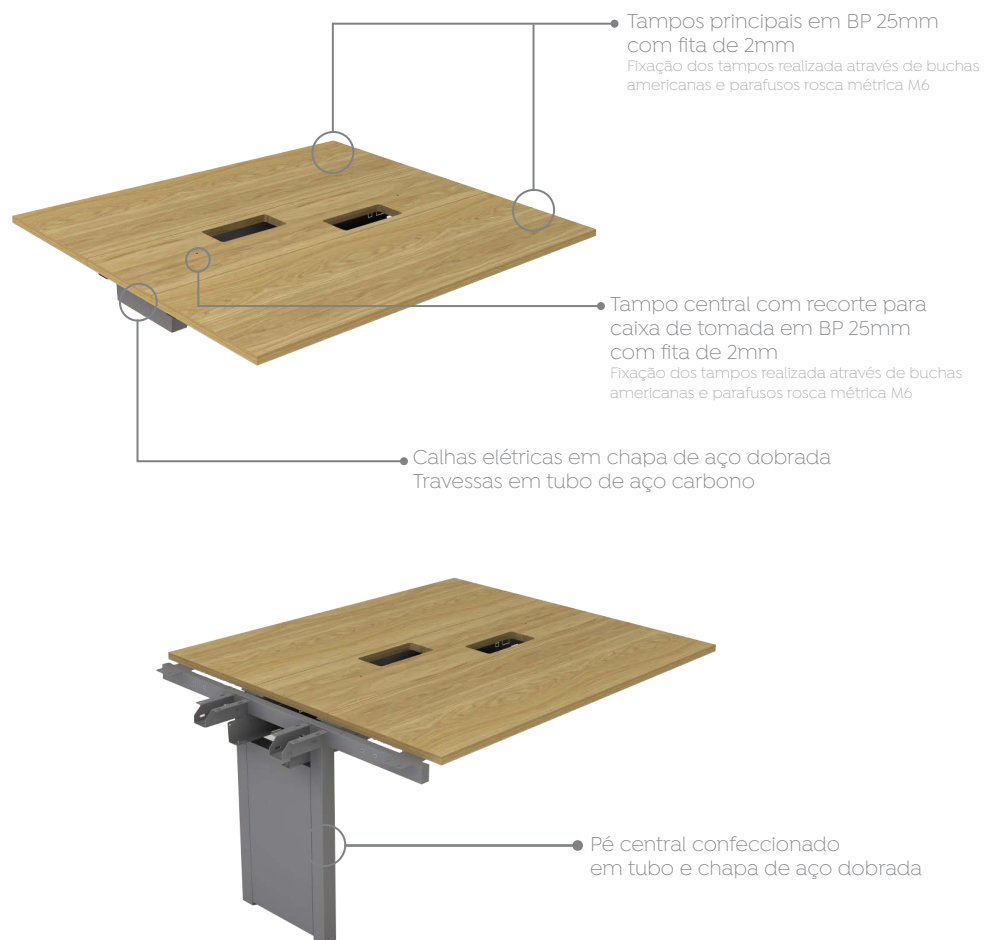

Modelos



Módulo Central Duplo



Módulo Central Simples



Módulo Auxiliar Duplo



Módulo Auxiliar Simples

Pés para Plataformas

Pés Trave Elevados

Para plataformas Simples e Duplas



Pé Trave Elevado
Plataforma Dupla

Pés Quadro Elevados

Para plataformas Simples e Duplas



Pé Quadro Elevado
Plataforma Dupla

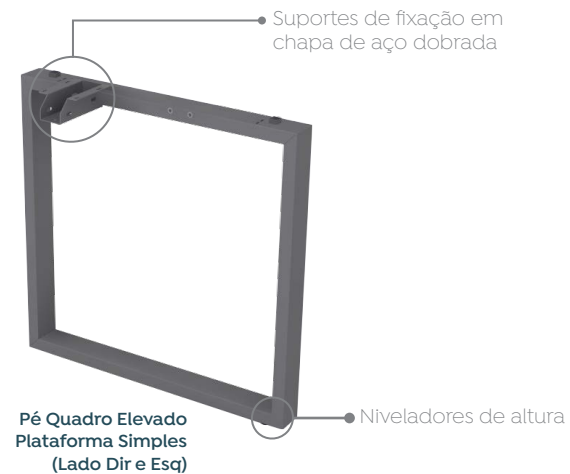
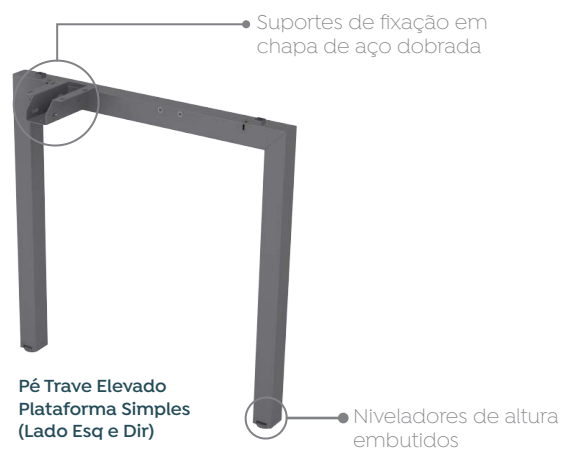

Pés Cavalete Elevados

Para plataformas Simples e Duplas

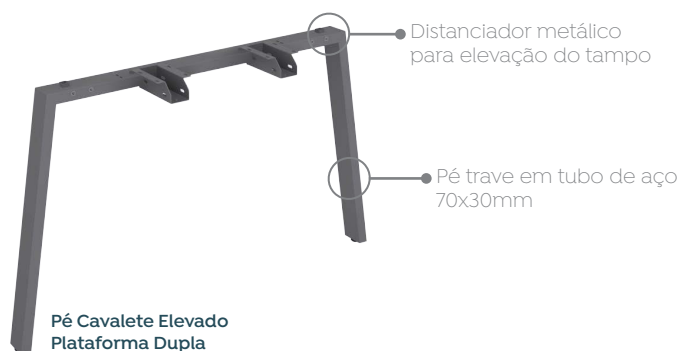

Pés Cavalete 3D

Para plataformas Simples e Duplas

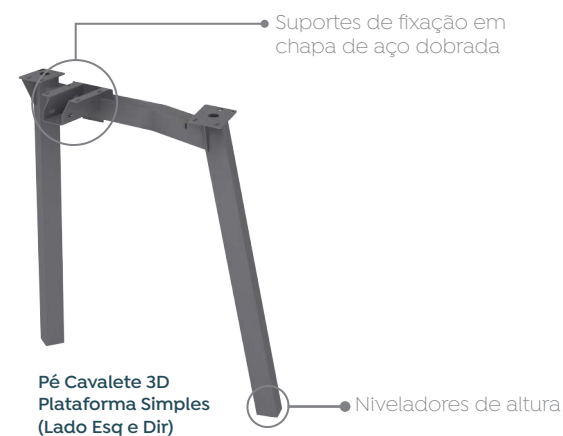
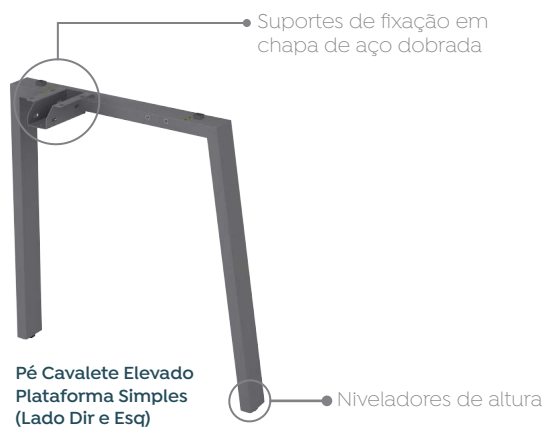

Pés Painel

Para plataformas Simples e Duplas



Pé Painel em BP 25mm
com fita de 2mm

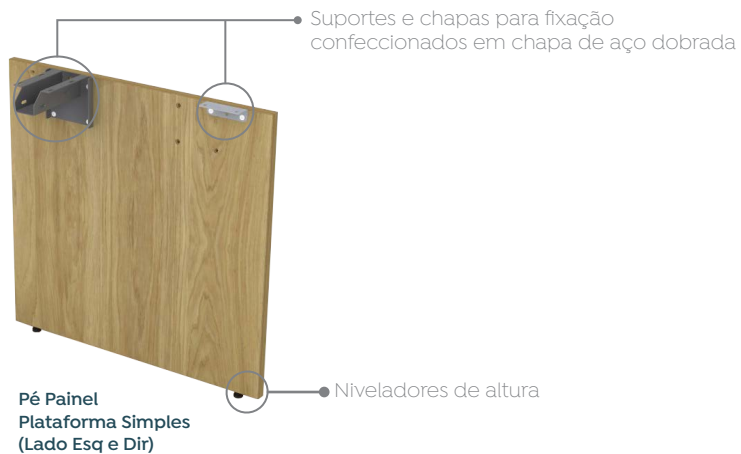

Montagem dos Módulos

Exemplo: Plataforma Dupla 4 lugares



- 1 Módulo Central Plataforma Dupla 120x120
- 2 Módulo Auxiliar Plataforma Dupla 120x120
- 3 Pé Trave Elevado Plataforma Dupla 120P

* O Procedimento para montagem de módulos é igual para Plataformas Simples e Duplas.

Sistema de montagem

1. Solte um dos pés do Módulo Central (pode ser qualquer um dos lados).

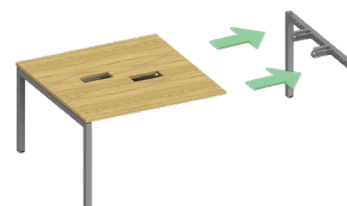

2. Acrescente o Módulo Auxiliar e fixe-o no lugar onde estava o pé lateral retirado no passo anterior.

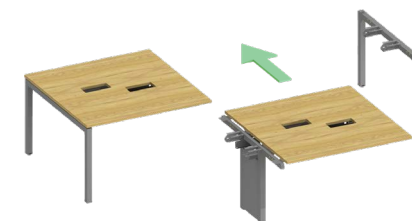

3. Com o Módulo Auxiliar devidamente fixado, faça o fechamento da plataforma com o pé lateral que foi solto no 1º passo.



4. Fixe os parafusos dos pés para finalizar a montagem.



Obs: Se for necessário inserir mais módulos, antes de fazer o fechamento deve-se repetir o 2º passo até atingir a quantidade de lugares desejada.

Eletrificação

Exemplo: Plataforma Dupla 4 lugares



Eletrocalhas para alocar a fiação cobrindo toda a extensão da plataforma, proporcionando segurança, organização e um visual limpo de cabos e fios.

Calhas de acabamento nos pés centrais escondendo a fiação.

Molduras modelo “Basic M Plugate” (vendidas separadamente)

* Conectores e tomadas não inclusos



Exemplos de montagens de Plataformas de Trabalho



- ❶ Módulo Central Plataforma Dupla 120x120
- ❷ Módulo Auxiliar Plataforma Dupla 120x120
- ❸ Pé Cavalete 3D Duplo para Plataforma 120P
- ❹ Moldura Caixa de Tomada Basic M
- ❺ Biombo de Vidro para Plataforma 120L

Exemplos de montagens de Plataformas de Trabalho



- 1 Módulo Central Plataforma Dupla 120x120
- 2 Módulo Auxiliar Plataforma Dupla 120x120
- 3 Pé Quadro Elevado Duplo para Plataforma 120P
- 4 Moldura Caixa de Tomada Basic M
- 5 Biombo com Friso para Plataforma 115L
- 6 Gaveteiro Volante 1 Gav + Pasta Puxador Lateral (Impéria Premium)
- 7 Porta Canetas EasyFix
- 8 Porta Clips EasyFix



Mesas Tubulares

Sumário (selecione o item) 

Tampos para Mesa Tubular.....	23
Tampo Mesa Tubular c/ Rasgo p/ Cx de Tomadas Face Sup Cent	23
Tampo Mesa Tubular c/ Rasgo p/ Cx de Tomadas Centralizado	23
Tampo Mesa Tubular	23
Estrutura Mesa Tubular.....	23
Mesa Trapezoidal	23

Tampos para Mesa Tubular

Tampo Mesa Tubular com Rasgo p/ Cx de Tomadas Face Superior Centralizado

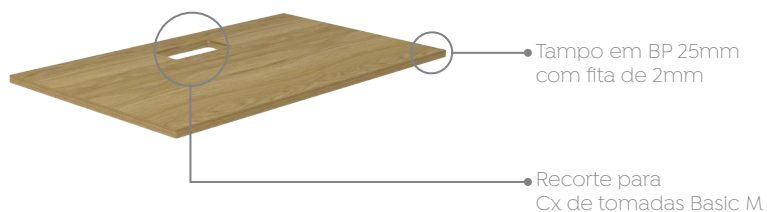

Tampo Mesa Tubular com Rasgo p/ Cx de Tomadas Centralizado

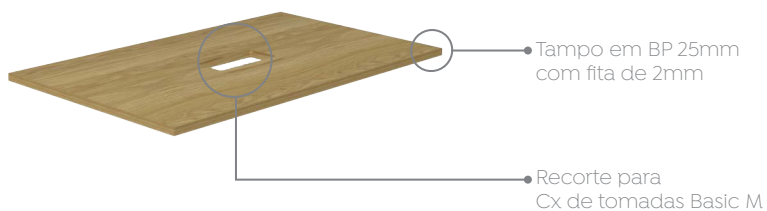

Tampo Mesa Tubular com Rasgo p/ Cx de Tomadas Centralizado

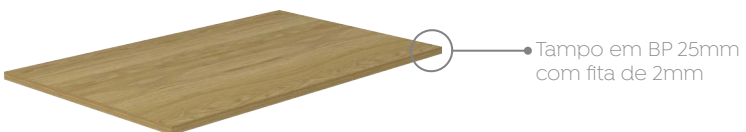

Estrutura Mesa Tubular

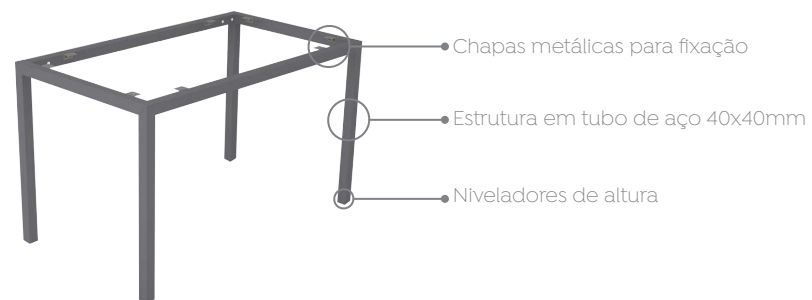

Mesa Trapezoidal





Diretivas

Sumário (selecione o item) 

Mesas Diretivas	26
Diretiva Sem Pés, Sem Rasgo p/ Caixa de Tomada	26
Diretiva Sem Pés, Com Rasgo p/ Caixa de Tomada	26
Diretiva Sem Pés, p/ Armário e Pé 3D Esq/Dir Sem Rasgo p/ Caixa de Tomada	27
Diretiva Sem Pés, p/ Armário e Pé 3D Esq/Dir Com Rasgo p/ Caixa de Tomada	27
Pés para Mesas Diretivas	28
Pé Trave Elevado p/ Mesa Diretiva	28
Pé Quadro Elevado p/ Mesa Diretiva	28
Pé Cavalete Elevado Duplo p/ Mesa Diretiva	28
Pé Cavalete Elevado Dir/Esq p/ Mesa Diretiva	28
Pé Cavalete 3D Duplo p/ Mesa Diretiva	29
Pé Cavalete 3D Esq/Dir p/ Mesa Diretiva	29
Pé Painel p/ Mesa Diretiva	29
Trave Elevada p/ Armário Diretiva	29
Trave Elevada Armário Diretiva Tubo 50x50	29
Trave Elevada Armário Diretiva Tubo 70x30	29

Armários Diretiva	30
Armários Diretiva / Modelos	30
Gaveteiros Diretiva	31
Gaveteiros Diretiva / Modelos	31
Exemplos de Montagem	32



Mesas Diretivas

Diretiva Sem Pés Sem Rasgo p/ Caixa de Tomada

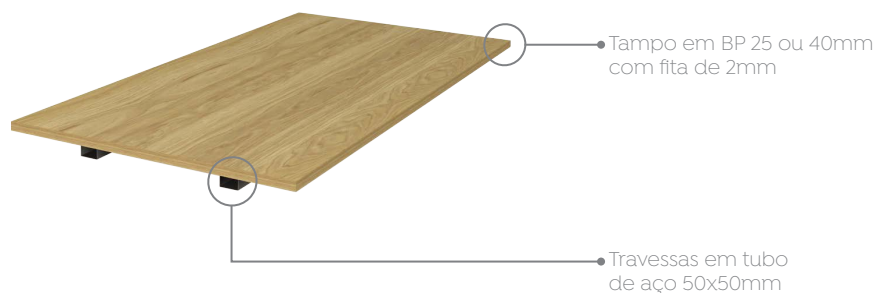

Modelos de pés que podem ser utilizados:



Diretiva Sem Pés Com Rasgo p/ Caixa de Tomada

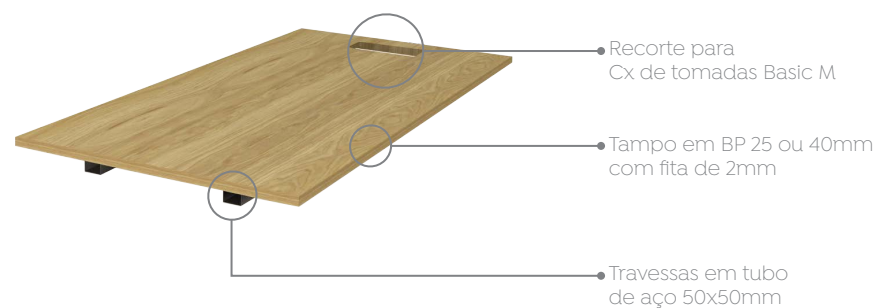

Montagens:

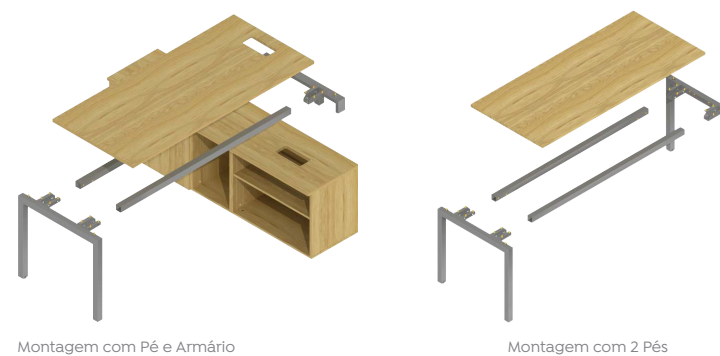

Mesas Diretivas

Diretiva Sem Pés para Armário e Pé 3D Esq/Dir Sem Rasgo para Caixa de Tomada

* Utilizar apenas com o Pé Cavalete 3D Esq/Dir (1 travessa)

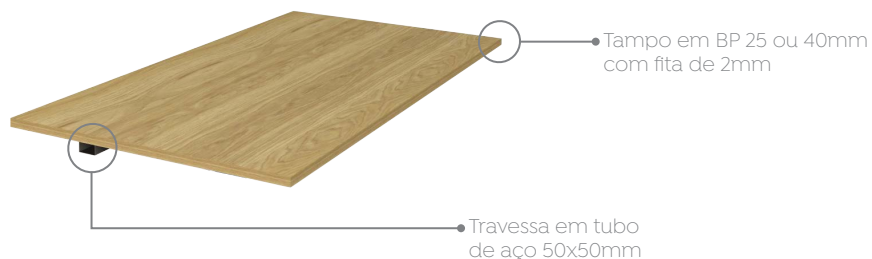

Diretiva Sem Pés para Armário e Pé 3D Esq/Dir Com Rasgo para Caixa de Tomada

* Utilizar apenas com o Pé Cavalete 3D Esq/Dir (1 travessa)

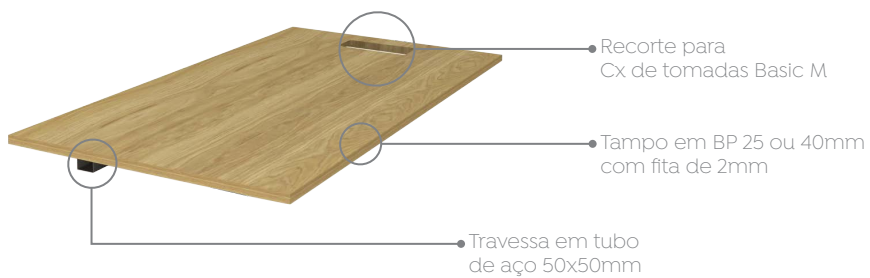

Modelos de pés que podem ser utilizados:



Pé Cavalete 3D Esq/Dir



Trave Armário Diretiva Tubo 50x50



Trave Armário Diretiva Tubo 70x30

Montagens:



Montagem com Pé e Armário

* Montagem com apenas 1 travessa

Pés para Mesas Diretivas

Pé Trave Elevado p/ Mesa Diretiva

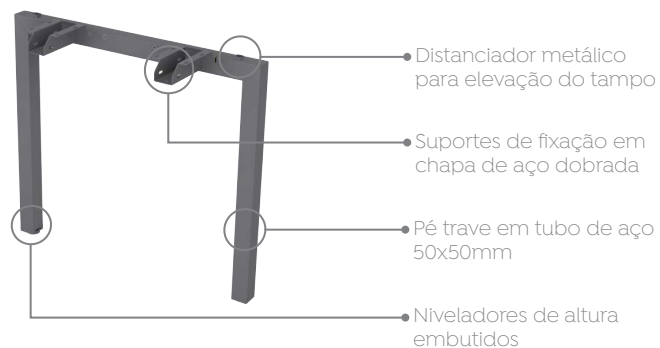

Pé Cavalete Elevado Duplo p/ Mesa Diretiva



Pé Quadro Elevado p/ Mesa Diretiva



Pé Cavalete Elevado Dir/Esq p/ Mesa Diretiva



Pés para Mesas Diretivas

Pé Cavalete 3D Duplo p/ Mesa Diretiva

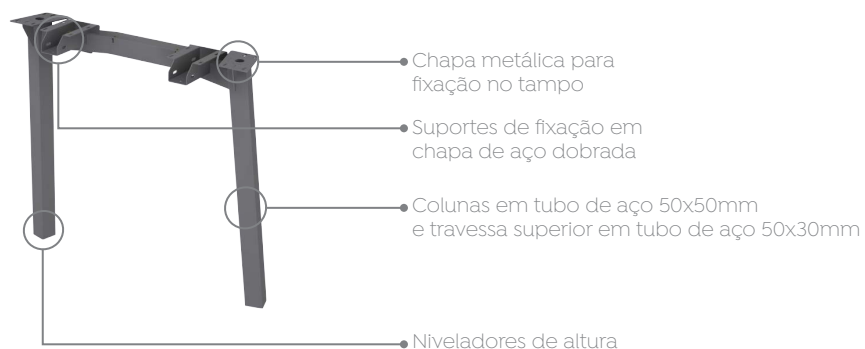

Pé Cavalete 3D Esq/Dir p/ Mesa Diretiva

* Atenção ao modelo da mesa p/ Pé 3D Esq/Dir (1 travessa)

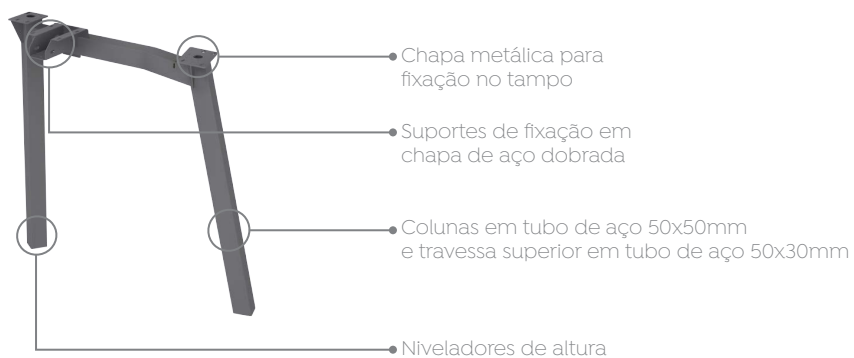

Pé Painel p/ Mesa Diretiva

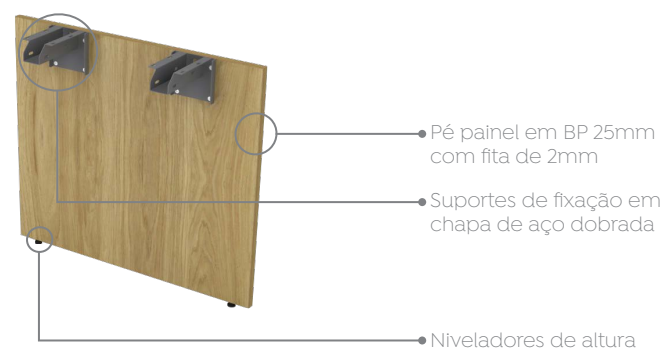

Trave Elevada para Armário Diretiva

Trave Elevada Armário Diretiva Tubo 50X50mm



Trave Elevada Armário Diretiva Tubo 70X30mm



Armários Diretiva

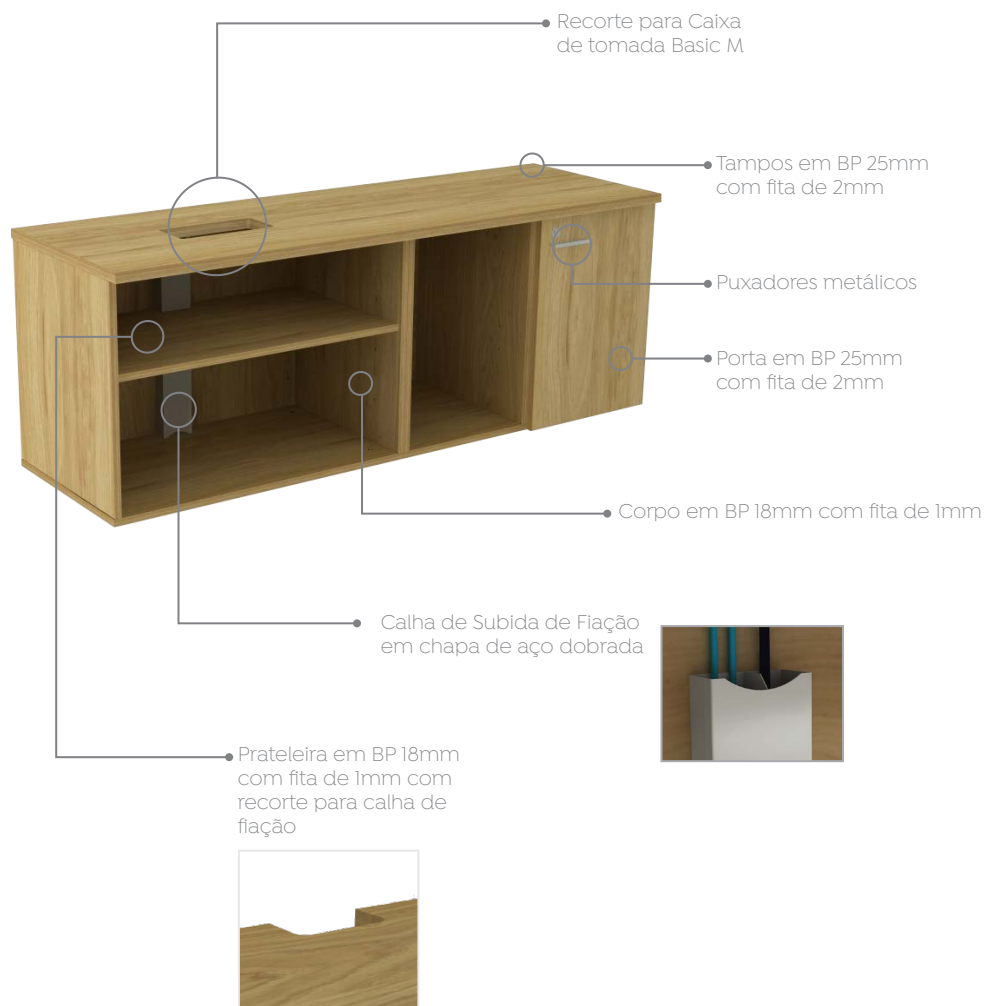

Modelos



Armário Diretiva 3 Módulos
Porta BP Lado Direito



Armário Diretiva 3 Módulos
Porta BP Lado Esquerdo



Armário Diretiva 4 Módulos
Porta BP Lado Direito



Armário Diretiva 4 Módulos
Porta BP Lado Esquerdo



Armário Diretiva 4 Módulos
Porta BP de Correr Lado Direito



Armário Diretiva 4 Módulos
Porta BP de Correr Lado Esquerdo.



Armário Complemento
1 Módulo



Armário Complemento
2 Módulos

Gaveteiros Diretiva

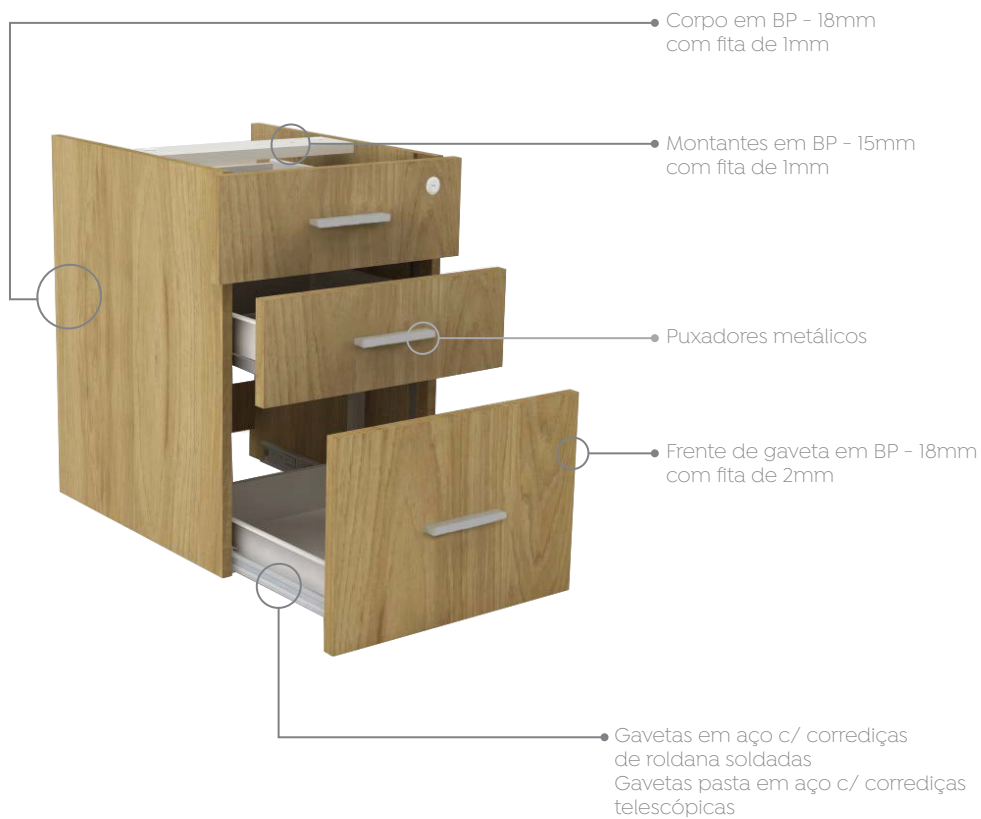

Modelos



Gaveteiro 2 Gavetas + Pasta para Armário Diretiva



Gaveteiro 4 Gavetas para Armário Diretiva

Exemplo: Aplicação do Gaveteiro no Armário Diretiva



- 1 Armário Diretiva 3 Módulos Porta BP Lado Direito
- 2 Gaveteiro 4 Gavetas para Armário Diretiva

Exemplo de montagem Mesa Diretiva



- 1 Diretiva Sem Pés Com Rasgo Caixa Tomada 180x80
- 2 Pé Cavalete Elevado Duplo p/ Mesa Diretiva
- 3 Trave Elevada Armário Diretiva Tubo 70x30 *
- 4 Armário Diretiva 4 Módulos Porta BP Lado Esquerdo
- 5 Gaveteiro 4 Gavetas para Armário Diretiva
- 6 Caixa de Tomada Basic M

Eletrificação



Calha de subida de fiação

Posições para Trave do Armário

A trave do armário possui 3 opções de fixação



Trave na posição Frontal
Mesa sem caixa
Caixa de tomada instalada no armário



Trave na posição Central
Mesa com caixa



Trave na posição Traseira
Mesa e armário sem caixa



Mesas Reunião

Sumário (selecione o item) 

Mesas Reunião.....	34
Reunião Sem Pé Central / modelos	34
Reunião Com Pé Central / modelos	35
Módulos Mesa Reunião	36
Módulos Reunião Sem Pé Central / modelos	36
Módulos Reunião Com Pé Central / modelos	37
Pés para Mesa Reunião	38
Pés Trave Elevados para Mesa Reunião	38
Pés Quadro Elevados para Mesa Reunião	38
Pés Cavalete Elevados para Mesa Reunião	39
Pés Cavalete 3D para Mesa Reunião	39
Pés Painel para Mesa Reunião	40
Montagens / Exemplos	41

Mesas Reunião

Reunião Sem Pé Central

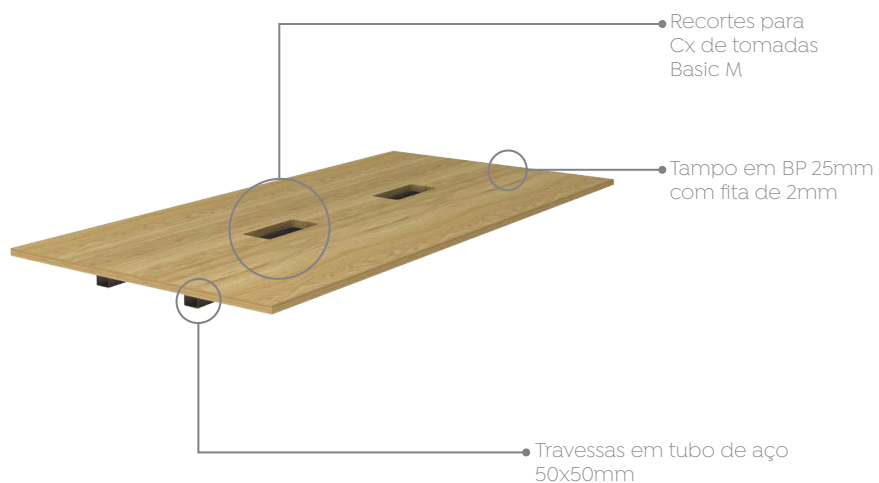

Modelos



Reunião Sem Pé Central,
Sem Cx de Tomada,
Travessa Longa



Reunião Sem Pé Central,
1 Cx de Tomada,
Travessa Longa



Reunião Sem Pé Central,
2 Cx de Tomada,
Travessa Longa



Reunião Sem Pé Central,
Sem Cx de Tomada,
Travessa Curta



Reunião Sem Pé Central,
1 Cx de Tomada,
Travessa Curta



Reunião Sem Pé Central,
2 Cx de Tomada,
Travessa Curta

Mesas Reunião

Reunião Com Pé Central

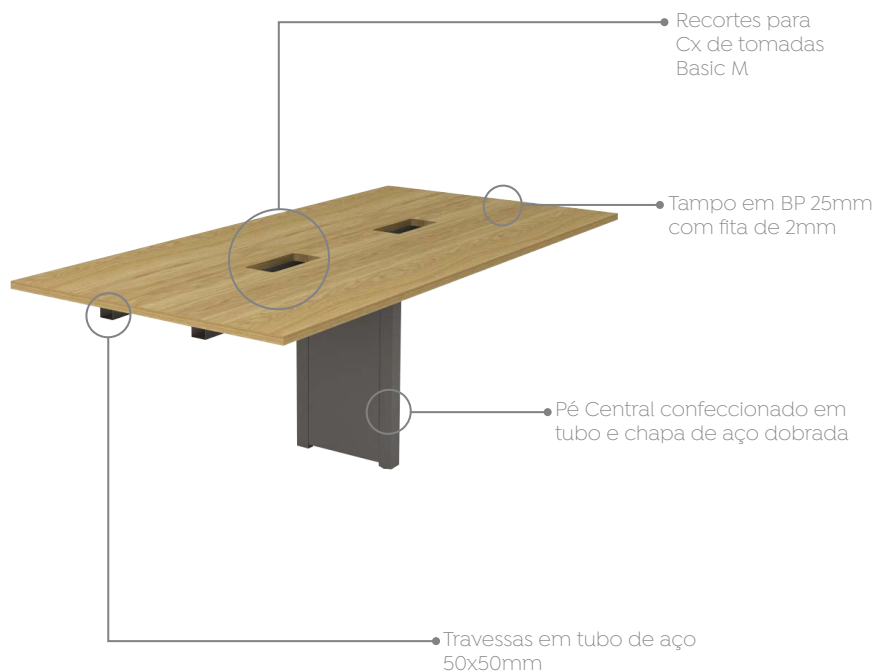

Modelos



Reunião Com Pé Central,
Sem Cx de Tomada,
Travessa Longa



Reunião Com Pé Central,
1 Cx de Tomada,
Travessa Longa



Reunião Com Pé Central,
2 Cx de Tomada,
Travessa Longa



Reunião Com Pé Central,
Sem Cx de Tomada,
Travessa Curta



Reunião Com Pé Central,
1 Cx de Tomada,
Travessa Curta



Reunião Com Pé Central,
2 Cx de Tomada,
Travessa Curta

Módulos Mesa Reunião

Módulo Reunião Sem Pé Central

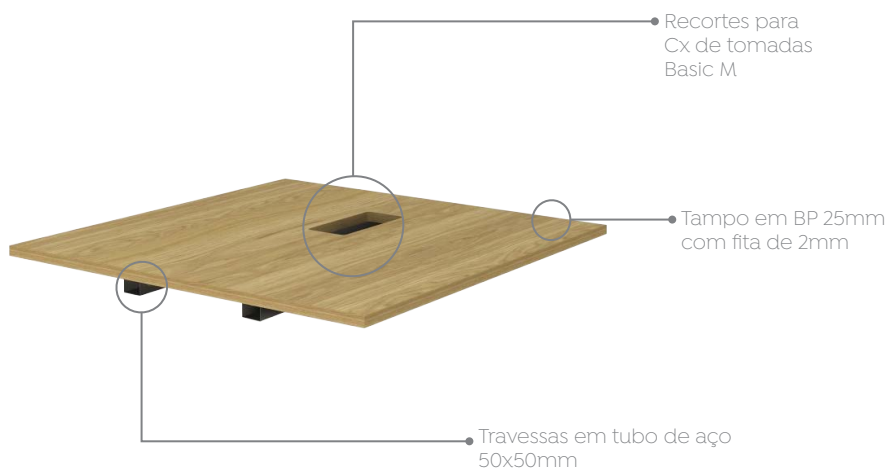

Modelos



Módulo Reunião Sem Pé Central, Sem Rasgo Cx Tomada, Travessa Longa



Módulo Reunião Sem Pé Central, Rasgo Cx Tomada Central Bipartida, Travessa Longa



Módulo Reunião Sem Pé Central, Rasgo Cx Tomada Esq/Dir, Travessa Longa



Módulo Reunião Sem Pé Central, Sem Rasgo Cx Tomada, Travessa Curta



Módulo Reunião Sem Pé Central, Rasgo Cx Tomada Central Bipartida, Travessa Curta



Módulo Reunião Sem Pé Central, Rasgo Cx Tomada Esq/Dir, Travessa Curta

Módulos Mesa Reunião

Módulo Mesa Reunião Com Pé Central



Modelos



Módulo Mesa Reunião Com Pé Central, Sem Cx de Tomada, Travessa Longa



Módulo Mesa Reunião Com Pé Central, Cx de Tomada Central Bipartida, Travessa Longa



Módulo Mesa Reunião Com Pé Central, Cx de Tomada Esq/Dir, Travessa Longa



Módulo Mesa Reunião Com Pé Central, Sem Cx de Tomada, Travessa Curta



Módulo Mesa Reunião Com Pé Central, Cx de Tomada Central Bipartida, Travessa Curta



Módulo Mesa Reunião Com Pé Central, Cx de Tomada Esq/Dir, Travessa Curta

Pés para Mesas Reunião

Pés Trave Elevados para Mesa Reunião

Para mesas reunião com pés rentes ou recuados

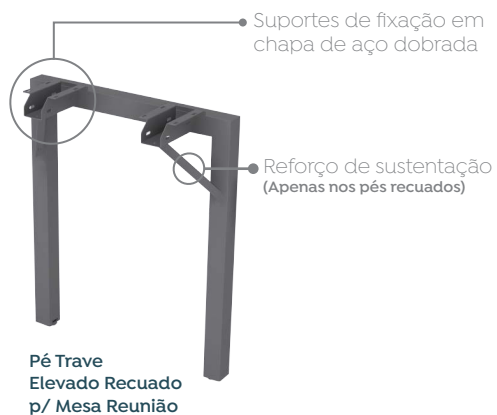

Pés Quadro Elevados para Mesa Reunião

Para mesas reunião com pés rentes ou recuados



Pés para Mesas Reunião

Pés Cavalete Elevados para Mesa Reunião

Para mesas reunião com pés rentes ou recuados

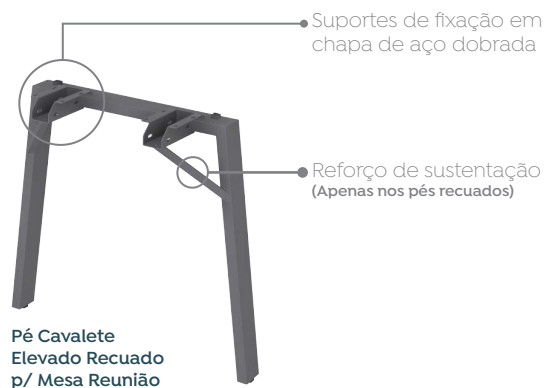

Pés Cavalete 3D para Mesa Reunião

Para mesas reunião com pés rentes ou recuados

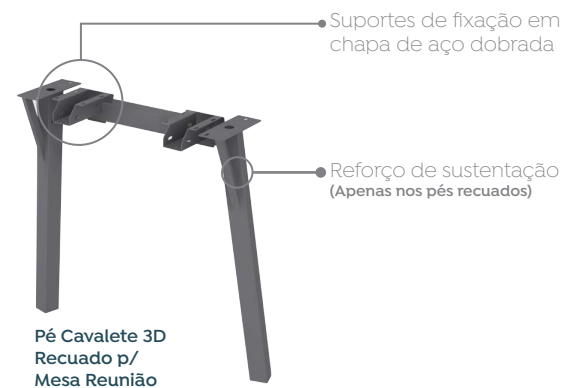
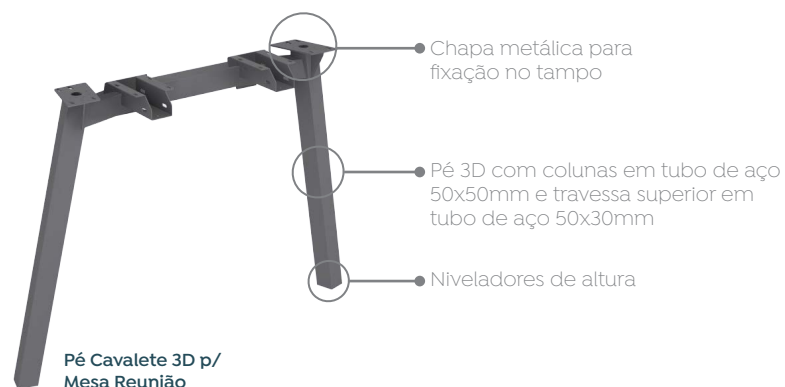

Pés para Mesas Reunião

Pés Painel para Mesa Reunião

Para mesas reunião com pés rentes ou recuados

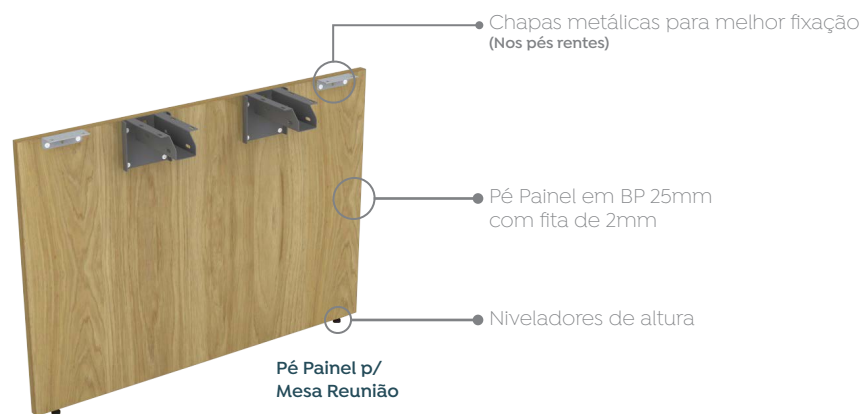

Montagem das Mesas Reunião (Tampo inteiriço)

Exemplo:

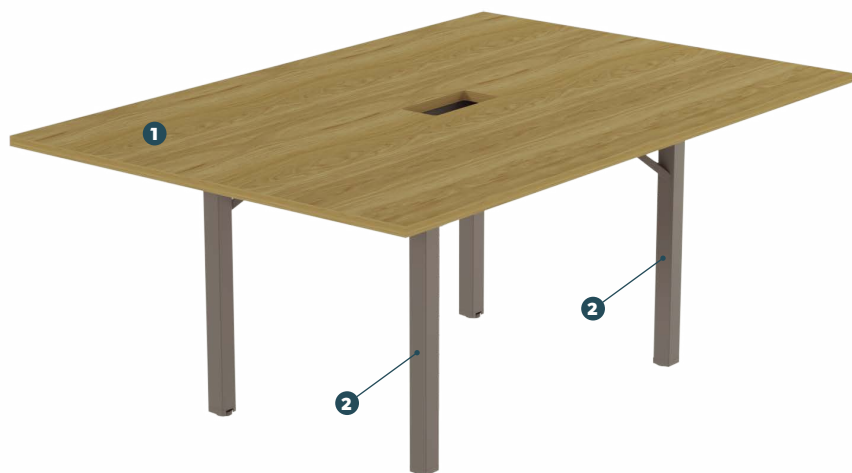

- 1 Reunião Sem Pé Central | Rasgo Cx de Tomada, Travessa Curta 1800x1200
- 2 Pé Trave Elevado Recuado p/ Mesa Reunião 690P

* O Procedimento para montagem das mesas é igual para mesas com pés rentes ou recuados.

Sistema de montagem

1. As reuniões possuem tampo inteiriço.
Fixar os pés nas extremidades das travessas e no tampo.
(o mesmo se aplica as mesas com pé central)



2. Mesa Reunião montada



(Vista inferior)

Exemplo de montagem: Mesa Reunião Sem Pé Central (Tampo inteiriço)



Eletrificação



Opção de utilização de vertebra guia para subida de fiação até a calha elétrica.

Exemplo de montagem: Mesa Reunião Com Pé Central (Tampo inteiriço)

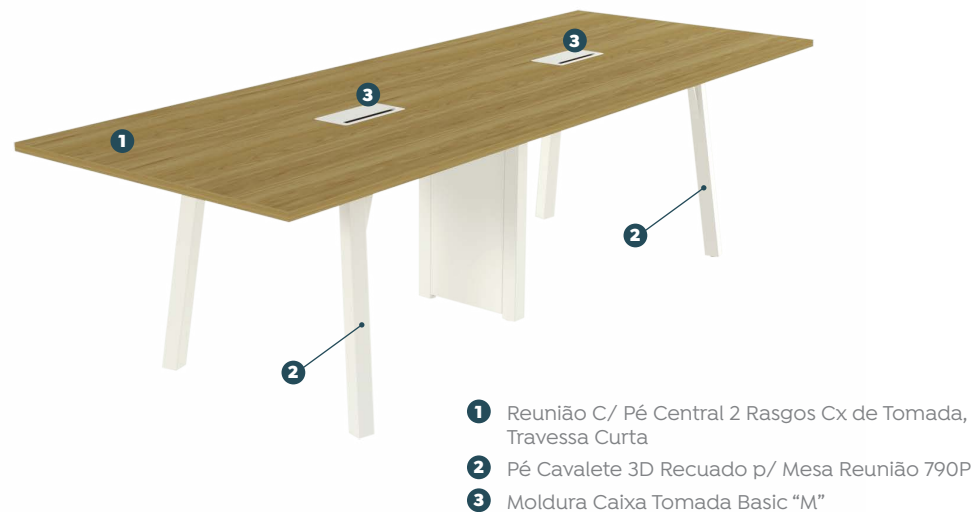

Eletrificação



Opção de subida de fiação pelo pé central.

Montagem das Mesas Reunião por Módulos (Tampo Bipartido)

Exemplo:



- 1 Módulo Reunião S/ Pé Central, Rasgo Cx Tomada Esq/Dir, Travessa Curta 150x120
- 2 Módulo Reunião C/ Pé Central, Rasgo Cx Tomada Esq/Dir, Travessa Curta 150x120
- 3 Pé Trave Elevado Recuado p/ Mesa Reunião 690P

Sistema de montagem

As mesas formadas por módulos possuem tampo bipartido.

1. Fazer a união dos módulos e o fechamento com os pés laterais.

Utilizar **1 módulo sem pé central para o início** da mesa, e **1 ou mais módulos com pé central para compor o restante** da mesa de acordo com o tamanho desejado.

Regras: Os módulos iniciais (os 2 módulos mostrados abaixo) **devem possuir o mesmo padrão de comprimento de travessas**, ou seja, os 2 com travessas longas ou os 2 com travessas curtas.

A partir do **3º módulo, deve-se incluir sempre módulos com pé central e travessas longas.**

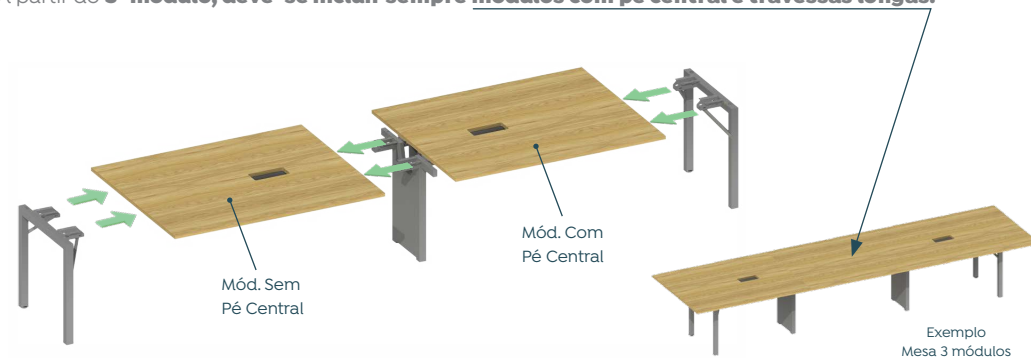

2. Mesa Reunião montada



Exemplo de montagem:
Mesa Reunião 2 Módulos Travessa Longa (Tampo Bipartido)



Exemplo de montagem:
Mesa Reunião 2 Módulos Travessa Curta (Tampo inteiroço)



Eletrificação



Opção de subida de fiação pelo pé central.



Armários

Sumário (selecione o item) 

Armários	46
Armários Baixo, Médio, Alto, Teto e Credence / Modelos	46
Armários Porta PVC Baixo e Médio / Modelos	47
Armários Plataforma Porta PVC Baixo e Médio / Modelos	48
Armários Futon / Modelos	49
Armários Nicho / Modelos	50

Armários

Armários Baixo, Médio, Alto, Teto e Credence



Modelos



Armário Baixo
Fechado Secretária



Armário Médio
Fechado Diretor



Armário Alto
Fechado Diretor



Armário Alto
Executivo



Armário Teto
Fechado Diretor



Armário Credence Duplo



Armário Credence Triplo

Armários

Armários Porta PVC Baixo e Médio

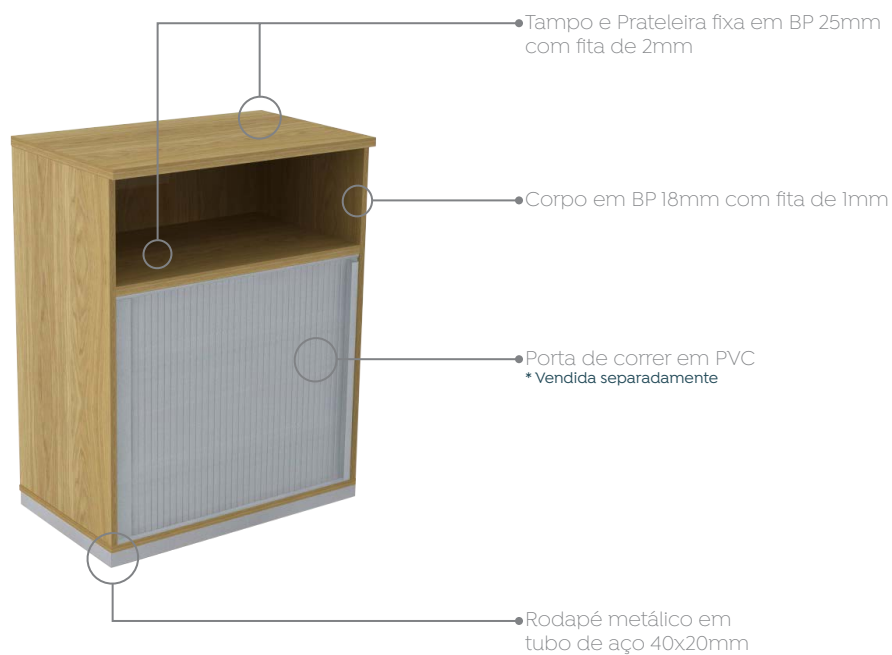

Modelos



Armário Baixo
P/ Porta PVC



Armário Médio
P/ Porta PVC

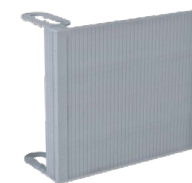

Porta PVC P/ Armário

Exemplos:



* Armários e Portas PVC são vendidos separadamente

Armários

Armários Plataforma Porta PVC Baixo e Médio

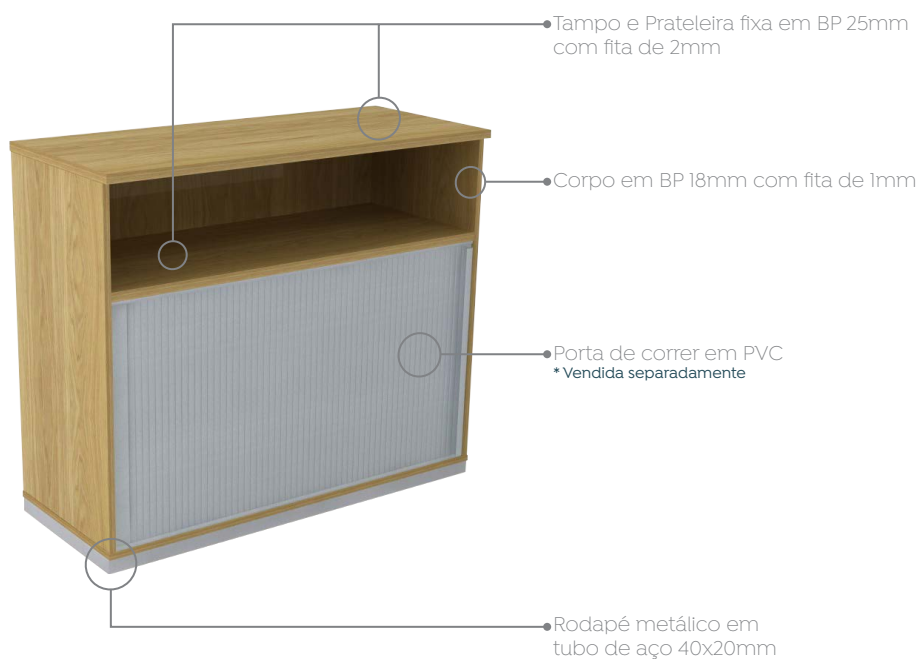

Modelos



Armário Baixo Plataforma
P/ Porta PVC



Armário Médio Plataforma
P/ Porta PVC

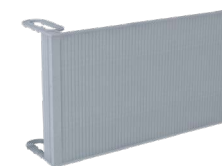

Porta PVC P/ Armário
Plataforma

* Armários e Portas PVC são vendidos separadamente

Exemplos:



Armários

Armários Futon



Modelos



Armário Futon* Lado Esquerdo



Armário Futon* Lado Direito

*Futons vendidos separadamente

Exemplos:



Armários

Armários Nicho

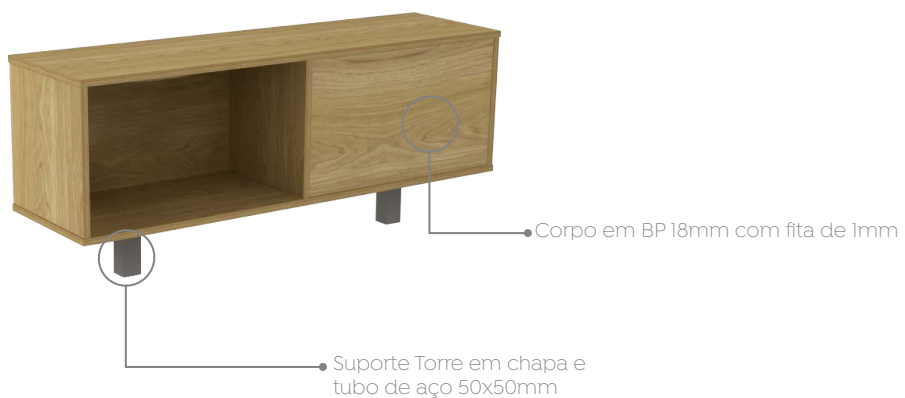

* Armários e Portas PVC são vendidos separadamente

Modelos



Armário Nicho Aberto



Armário Nicho Porta BP



Armário Nicho Porta PVC



Porta PVC P/ Armário Nicho

Exemplos:





Complementos

Sumário (selecione o item) 

Biombos	53
Biombo com Friso para Plataforma	53
Biombo com Friso para Armário	53
Biombo com Friso para Diretiva	53
Biombo sem Friso para Plataforma	53
Biombo de Vidro para Plataforma	54
Biombo Divisória Lateral para Plataforma	54
Painel Frontal	54
Prateleiras	55
Prateleira Com Torre p/ Plataforma Dupla	55
Prateleira Com Torre p/ Plataforma Simples	55
Suporte para Gabinete	56
Suporte Gabinete Simples	56
Suporte Gabinete Duplo	56
Vertebra Guia	56
Pé Auxiliar Armário Nicho	56

Painéis de Fechamento	57
Módulo Painel Fechamento Direito Armário 3 Módulos	57
Módulo Painel Fechamento Direito Armário 4 Módulos	57
Módulo Painel Fechamento Esquerdo Armário 3 Módulos	57
Módulo Painel Fechamento Esquerdo Armário 4 Módulos	57
Módulo Painel Fechamento Direito Armário 3 Módulos c/ Prateleira	58
Módulo Painel Fechamento Direito Armário 4 Módulos c/ Prateleira	58
Módulo Painel Fechamento Esquerdo Armário 3 Módulos c/ Prateleira	58
Módulo Painel Fechamento Esquerdo Armário 4 Módulos c/ Prateleira	58
Módulo Painel Fechamento Central	59
 Sofás	60
Sofá 2 Lugares	60
Sofá 1 Lugar	60
 Futons	61
Tampo Futon para Armário Futon	61
Tampo Futon para Amário Diretiva	61
Tampo Futon para Gaveteiro	61



Biombos

Biombo Com Friso para Plataforma

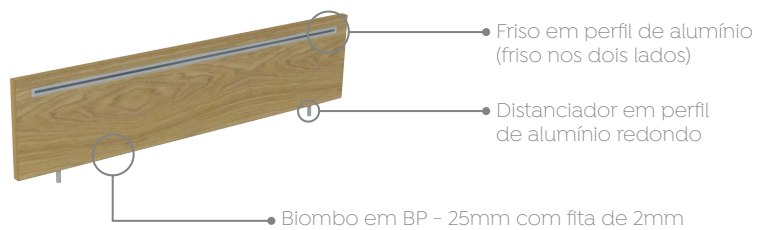

Biombo Com Friso Para Diretiva

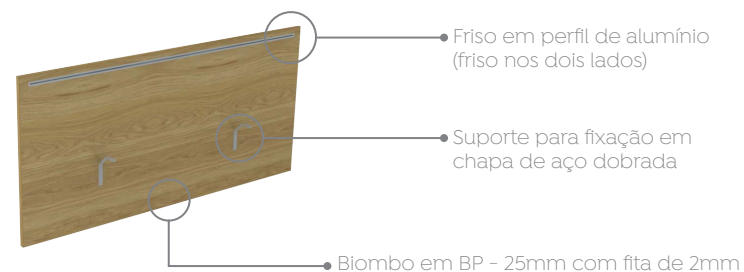

Biombo Com Friso Para Armário

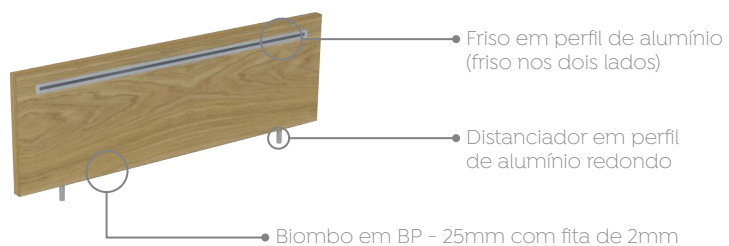

Biombo Sem Friso Para Plataforma



Biombo De Vidro para Plataforma

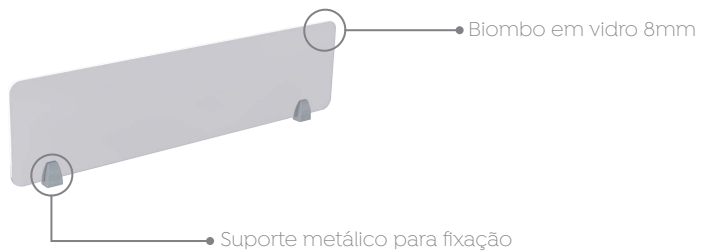

Biombo Divisória Lateral Plataforma

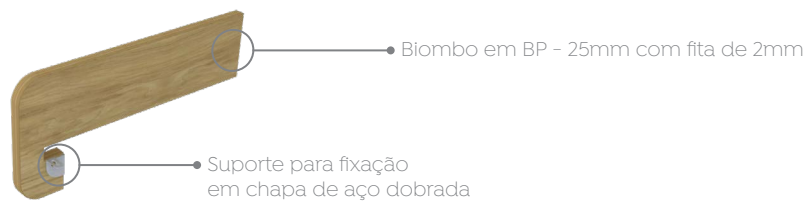

Exemplos de Aplicação de Biombos:



Painel Frontal

Painel Frontal para Plataforma Simples, Mesa Diretiva e Mesa Tubular

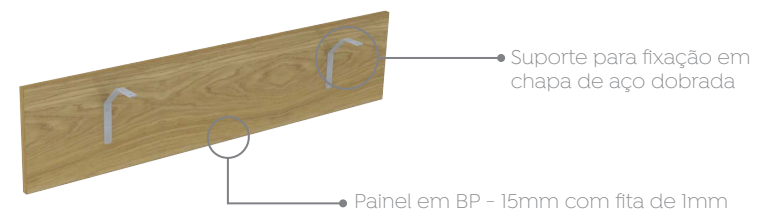

Prateleiras

Prateleira Com Torre Para Plataforma Dupla

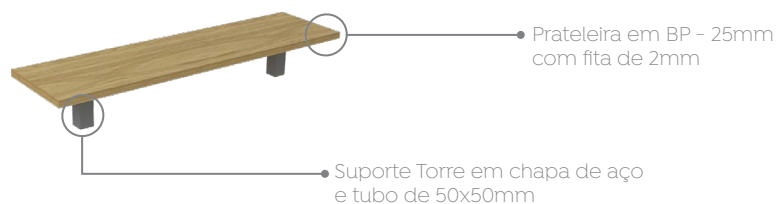

Prateleira Com Torre Para Plataforma Simples



Exemplos:



Suporte para Gabinete

Suporte Gabinete Simples

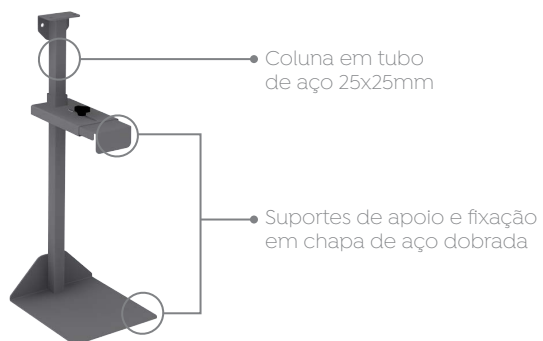

Suporte Gabinete Duplo

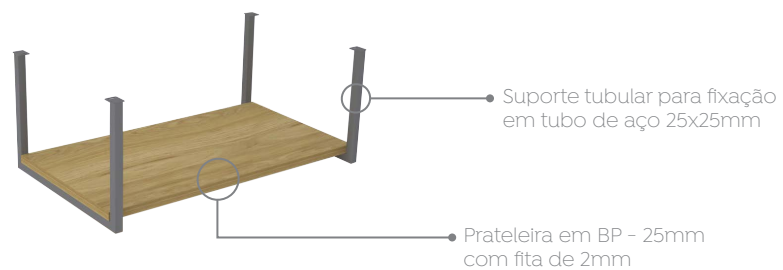

Vertebra Guia

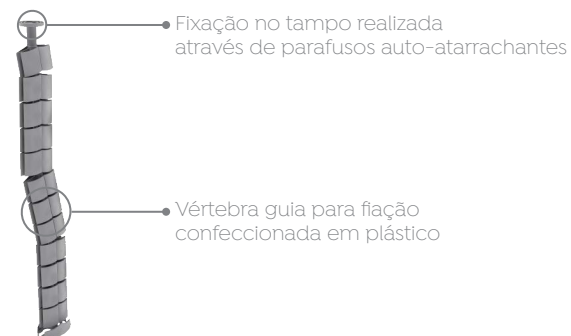

Pé Auxiliar Armário Nicho

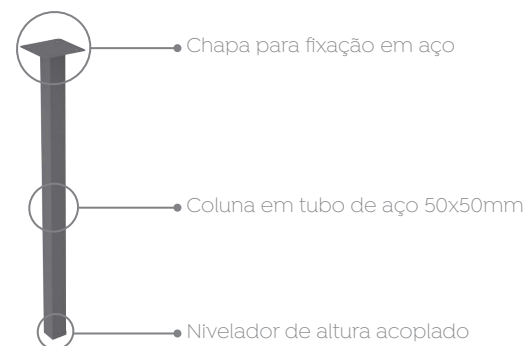

Painéis de Fechamento

Módulo Painel Fechamento Direito Armário 3 Módulos

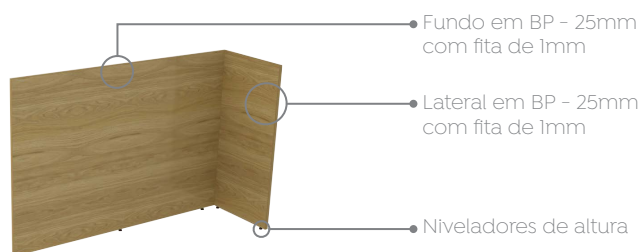

Módulo Painel Fechamento Esquerdo Armário 3 Módulos

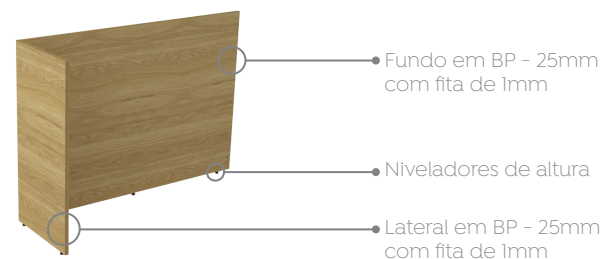

Módulo Painel Fechamento Direito Armário 4 Módulos

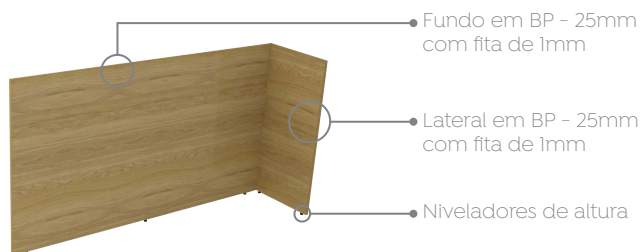

Módulo Painel Fechamento Esquerdo Armário 4 Módulos

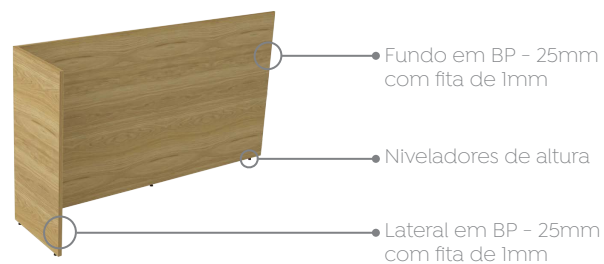

Módulo Painel Fechamento Direito Armário 3 Módulos C/ Prateleira

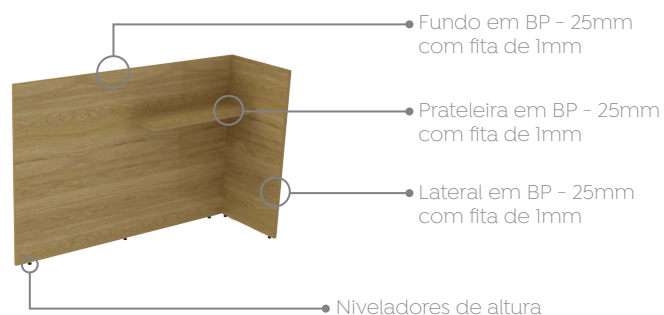

Módulo Painel Fechamento Esquerdo Armário 3 Módulos Com Prateleira

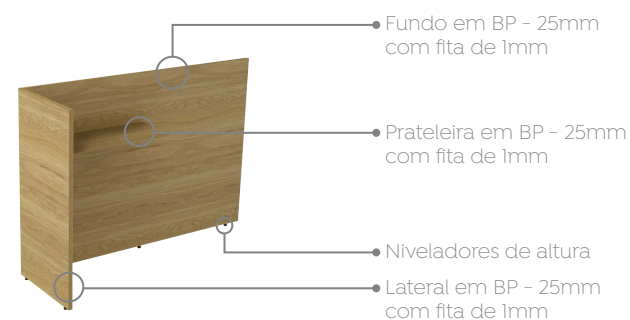

Módulo Painel Fechamento Direito Armário 4 Módulos Com Prateleira

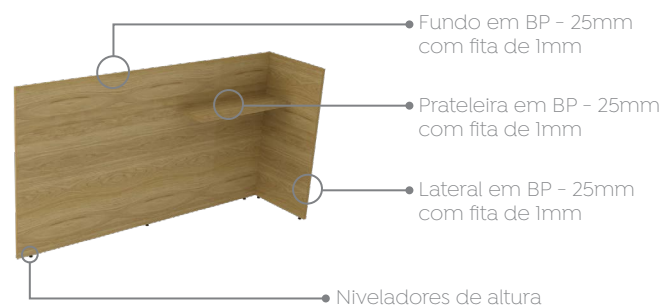

Módulo Painel Fechamento Esquerdo Armário 4 Módulos Com Prateleira

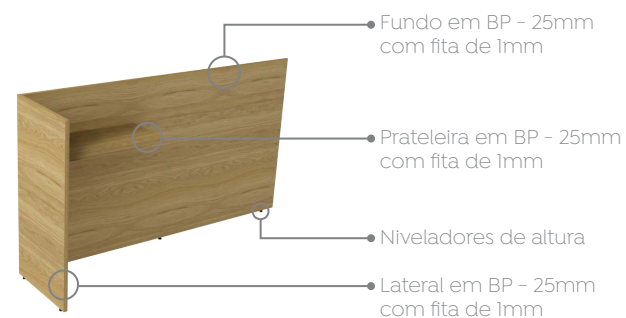

Módulo Painel Fechamento Central

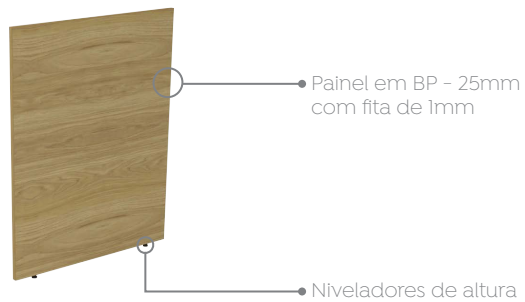

Exemplos:



Sofás

Sofá 2 Lugares



• Estrutura em madeira.
Revestimento em espuma e tecido

Sofá 1 Lugar

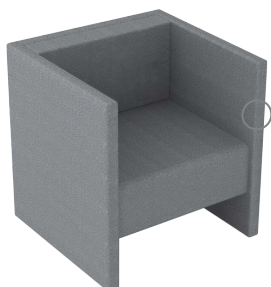

• Estrutura em madeira.
Revestimento em espuma e tecido

Exemplo:



Futons

Tampo Futon Para Armário Futon



Tampo Futon para Armário Diretiva



Tampo Futon para Gaveteiro

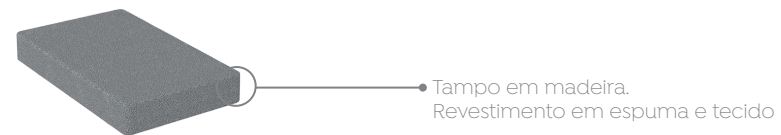

Exemplos:





Bancadas

Sumário (selecione o item) 

Bancadas.....	63
Bancada sem Rasgo para Caixa de Tomadas	63
Bancada com Rasgo para Caixa de Tomadas	63

Bancadas

Bancada sem Rasgo para Cx de Tomadas



Bancada com Rasgo para Cx de Tomadas*

*Rasgo para Caixa de Tomadas modelo "Fit" tamanho M



Caixa de Tomadas "Fit" tamanho M

Configurações:



Caixas disponíveis nas cores:



WorkPro

www.marzovitorino.com.br

marzo vitorino